



Dell™ PowerEdge™ 800 Systems Installation and Troubleshooting Guide

[Introduction](#)
[Indicators, Messages, and Codes](#)
[Finding Software Solutions](#)
[Running the System Diagnostics](#)
[Troubleshooting Your System](#)
[Installing System Components](#)
[Installing Drives](#)
[Getting Help](#)
[Jumpers, Switches, and Connectors](#)
[I/O Connectors](#)

Notes, Notices, and Cautions

-  **NOTE:** A NOTE indicates important information that helps you make better use of your computer.
-  **NOTICE:** A NOTICE indicates either potential damage to hardware or loss of data and tells you how to avoid the problem.
-  **CAUTION:** A CAUTION indicates a potential for property damage, personal injury, or death.

Abbreviations and Acronyms

For a complete list of abbreviations and acronyms, see the Glossary in your *User's Guide*.

Information in this document is subject to change without notice.
© 2004 Dell Inc. All rights reserved.

Reproduction in any manner whatsoever without the written permission of Dell Inc. is strictly forbidden.

Trademarks used in this text: *Dell*, the *DELL* logo, *PowerEdge*, *PowerVault*, *Dell OpenManage*, *Dimension*, *Inspiron*, *OptiPlex*, *Latitude*, *Dell Precision*, *PowerApp*, *PowerConnect*, and *DellNet* are trademarks of Dell Inc.

Other trademarks and trade names may be used in this document to refer to either the entities claiming the marks and names or their products. Dell Inc. disclaims any proprietary interest in trademarks and trade names other than its own.

Initial release: 20 Aug 2004

[Back to Contents Page](#)

Jumpers, Switches, and Connectors

Dell™ PowerEdge™ 800 Systems Installation and Troubleshooting Guide

- [Jumpers—A General Explanation](#)
- [System Board Jumpers](#)
- [System Board Connectors](#)
- [SCSI Backplane Connectors](#)
- [Disabling a Forgotten Password](#)

This section provides specific information about the system jumpers. It also provides some basic information on jumpers and switches and describes the connectors on the various boards in the system.

Jumpers—A General Explanation

Jumpers provide a convenient and reversible way of reconfiguring the circuitry on a printed circuit board. When reconfiguring the system, you may need to change jumper settings on circuit boards or drives.

Jumpers

Jumpers are small blocks on a circuit board with two or more pins emerging from them. Plastic plugs containing a wire fit down over the pins. The wire connects the pins and creates a circuit. To change a jumper setting, pull the plug off its pin(s) and carefully fit it down onto the pin(s) indicated. [Figure A-1](#) shows an example of a jumper.

Figure A-1. Example Jumper

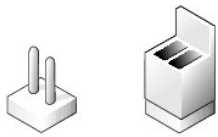

A jumper is referred to as open or unjumped when the plug is pushed down over only one pin or if there is no plug at all. When the plug is pushed down over two pins, the jumper is referred to as jumped. The jumper setting is often shown in text as two numbers, such as 1–2. The number 1 is printed on the circuit board with a triangle so that you can identify each pin number based on the location of pin 1.

[Figure A-2](#) shows the location and default settings of the server-module jumper blocks. See [Table A-1](#) for the designations, default settings, and functions of the jumpers.

System Board Jumpers

[Figure A-2](#) shows the location of the configuration jumpers on the system board. [Table A-1](#) lists the jumper settings.

 **NOTE:** To access the jumpers, remove the memory cooling shroud by lifting the release latch and sliding the shroud toward the front of the system. See [Figure 6-1](#).

Figure A-2. System Board Jumpers

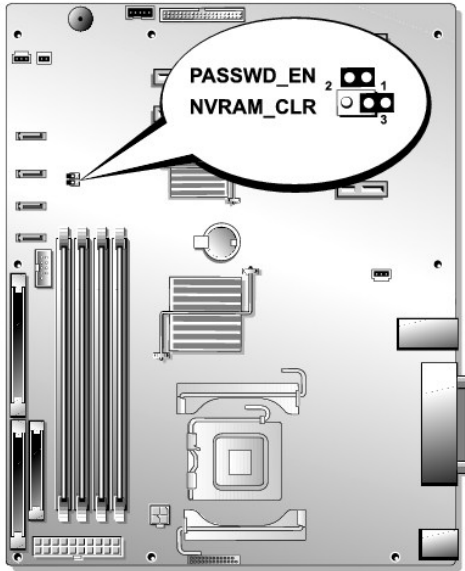





Table A-1. System Board Jumper Settings

Jumper	Setting	Description
PASSWD_EN	 (default)	The password feature is enabled.
		The password feature is disabled.
NVRAM_CLR	 (default)	The configuration settings in NVRAM are retained at system boot.
		The configuration settings in NVRAM are cleared at next system boot.

System Board Connectors

See [Figure A-3](#) and [Table A-2](#) for the location and description of the system board connectors.

Figure A-3. System Board Connectors

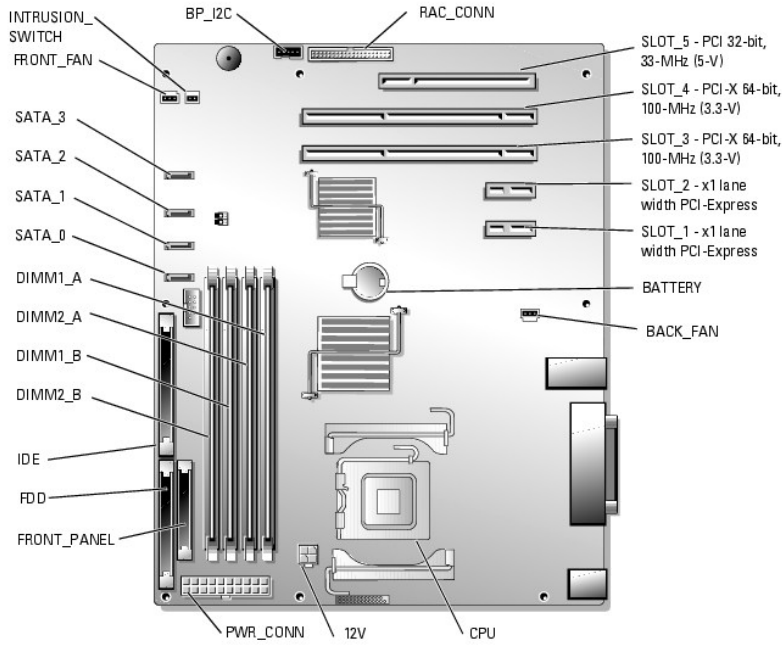

Table A-2. System Board Connectors

Connector	Description
12V	Power connector
BACK_FAN	Fan power connector
BATTERY	Connector for the 3.0-V coin battery
BP_I2C	Connector for the baseboard management controller (BMC) inter-IC (I2C) cable for the optional SCSI backplane
CPU	Processor connector
DIMM _{n_x}	Memory module connector (4)
FDD	Diskette drive connector
FRONT_FAN	Fan power connector
FRONT_PANEL	Control panel connector
IDE	IDE optical device connector
SLOT _n	PCI expansion slot connector
PWR_CONN	Power connector
RAC_CONN	Connector for the remote access controller (RAC)
SATA _n	SATA hard-drive connector

SCSI Backplane Connectors

See [Figure A-4](#) for the location and description of the connectors on the back of the optional SCSI backplane board.

Figure A-4. Connectors on Back of SCSI Backplane

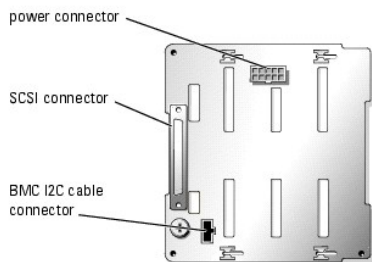

Disabling a Forgotten Password

The system's software security features include a system password and a setup password, which are discussed in detail in "Using the System Setup Program" in your *User's Guide*. The password jumper enables these password features or disables them and clears any password(s) currently in use.

 **CAUTION:** See your *Product Information Guide* for complete information about safety precautions, working inside the computer, and protecting against electrostatic discharge.

1. Turn off the system and attached peripherals, and disconnect the system from the electrical outlet.
2. Open the system. See "[Opening the System](#)" in "Troubleshooting Your System."
3. Remove the memory cooling shroud by lifting the release latch and sliding the shroud toward the front of the system. See [Figure 6-1](#).
4. Remove the password jumper plug.
See [Figure A-2](#) to locate the password jumper on the system board.
5. Replace the memory cooling shroud.
6. Close the system. See "[Closing the System](#)" in "Troubleshooting Your System."
7. Reconnect the system to the electrical outlet, and turn on the system.

The existing passwords are not disabled (erased) until the system boots with the password jumper plug removed. However, before you assign a new system and/or setup password, you must install the jumper plug.

 **NOTE:** If you assign a new system and/or setup password with the jumper plug still removed, the system disables the new password(s) the next time it boots.

8. Turn off the system, including any attached peripherals, and disconnect the system from the electrical outlet.
9. Open the system.
10. Remove the memory cooling shroud.
11. Reinstall the password jumper plug in its original position to enable the password protection feature.
12. Reinstall the memory cooling shroud.
13. Close the system, reconnect the system to the electrical outlet, and turn on the system.
14. Assign a new system and/or setup password.

To assign a new password using the System Setup program, see "Using the System Setup Program" in your *User's Guide*.

[Back to Contents Page](#)

I/O Connectors

Dell™ PowerEdge™ 800 Systems Installation and Troubleshooting Guide

- [Serial Connector](#)
- [Parallel Connector](#)
- [PS/2-Compatible Keyboard and Mouse Connectors](#)
- [Video Connector](#)
- [USB Connectors](#)
- [Integrated NIC Connectors](#)
- [Network Cable Requirements](#)

I/O connectors are the gateways that the system uses to communicate with external devices, such as a keyboard, mouse, printer, or monitor. This section describes the various connectors on your system. If you reconfigure the hardware connected to the system, you may also need the pin number and signal information for these connectors. [Figure B-1](#) illustrates the connectors on the system.

Figure B-1. I/O Connectors

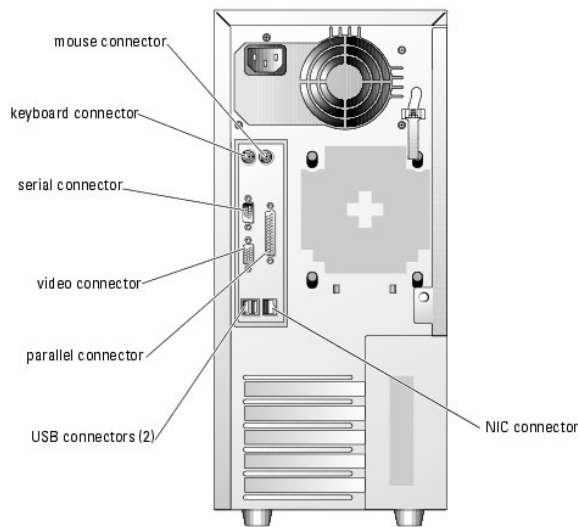

[Table B-1](#) shows the icons used to label the connectors on the system.

Table B-1. I/O Connector Icons

Icon	Connector
	Serial connector
	Parallel connector
	Mouse connector
	Keyboard connector
	Video connector
	USB connector
	NIC connector

Serial Connector

Serial connectors support devices such as external modems, printers, and mice that require serial data transmission. The serial connector is also used by the BMC to provide remote access to the system. The serial connector uses a 9-pin D-subminiature connector.

Serial Connector Autoconfiguration

The default designation of the integrated serial connector is COM1. When you add an expansion card containing a serial connector that has the same designation as the integrated connector, the system's autoconfiguration feature remaps (reassigns) the integrated serial connector to the next available designation. Both the new and the remapped COM connectors share the same IRQ setting. COM1 and COM3 share IRQ4, while COM2 and COM4 share IRQ3.

NOTE: If two COM connectors share an IRQ setting, you may not be able to use them both at the same time. In addition, if you install one or more expansion cards with serial connectors designated as COM1 and COM3, the integrated serial connector is disabled.

Before adding a card that remaps the COM connectors, check the documentation that came with the software to make sure that the software can accommodate the new COM connector designation.

[Figure B-2](#) illustrates the pin numbers for the serial connector and [Table B-2](#) defines the pin assignments for the connector.

Figure B-2. Serial Connector Pin Numbers

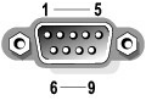

Table B-2. Serial Connector Pin Assignments

Pin	Signal	I/O	Definition
1	DCD	I	Data carrier detect
2	SIN	I	Serial input
3	SOUT	O	Serial output
4	DTR	O	Data terminal ready
5	GND	N/A	Signal ground
6	DSR	I	Data set ready
7	RTS	O	Request to send
8	CTS	I	Clear to send
9	RI	I	Ring indicator
Shell	N/A	N/A	Chassis ground

Parallel Connector

The integrated parallel connector, intended primarily for use by printers that require data in parallel format, uses a 25-pin D-subminiature connector on the system's back panel. The default designation of the system's parallel connector is LPT1. If you add an expansion card containing a parallel connector configured as LPT1 (IRQ7, I/O address 378h), use the System Setup program to remap the integrated parallel connector. See "Using the System Setup Program" in the *User's Guide*. [Figure B-3](#) illustrates the pin numbers for the parallel connector and [Table B-3](#) defines the pin assignments for the connector.

Figure B-3. Parallel Connector Pin Numbers

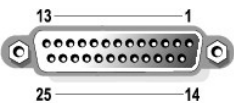

Table B-3. Parallel Connector Pin Assignments

Pin	Signal	I/O	Definition
1	STB#	I/O	Strobe
2	PD0	I/O	Printer data bit 0
3	PD1	I/O	Printer data bit 1
4	PD2	I/O	Printer data bit 2
5	PD3	I/O	Printer data bit 3
6	PD4	I/O	Printer data bit 4
7	PD5	I/O	Printer data bit 5
8	PD6	I/O	Printer data bit 6
9	PD7	I/O	Printer data bit 7
10	ACK#	I	Acknowledge

11	BUSY	I	Busy
12	PE	I	Paper end
13	SLCT	I	Select
14	AFD#	O	Automatic feed
15	ERR#	I	Error
16	INIT#	O	Initialize printer
17	SLIN#	O	Select in
18-25	GND	N/A	Ground

PS/2-Compatible Keyboard and Mouse Connectors

The PS/2-compatible keyboard and mouse cables attach to 6-pin, miniature DIN connectors. [Figure B-4](#) illustrates the pin numbers for these connectors and [Table B-4](#) defines the pin assignments for these connectors.

Figure B-4. PS/2-Compatible Keyboard and Mouse Connector Pin Numbers



Table B-4. Keyboard and Mouse Connector Pin Assignments

Pin	Signal	I/O	Definition
1	KBDATA or MDATA	I/O	Keyboard data or mouse data
2	NC	N/A	No connection
3	GND	N/A	Signal ground
4	FVcc	N/A	Fused supply voltage
5	KBCLK or MCLK	I/O	Keyboard clock or mouse clock
6	NC	N/A	No connection
Shell	N/A	N/A	Chassis ground

Video Connector

You can attach a VGA-compatible monitor to the system's integrated video controller using a 15-pin high-density D-subminiature connector on the system front or back panel. [Figure B-5](#) illustrates the pin numbers for the video connector and [Table B-5](#) defines the pin assignments for the connector.

NOTE: Installing a video card automatically disables the system's integrated video controller.

Figure B-5. Video Connector Pin Numbers

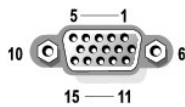

Table B-5. Video Connector Pin Assignments

Pin	Signal	I/O	Definition
1	RED	O	Red video
2	GREEN	O	Green video
3	BLUE	O	Blue video
4	NC	N/A	No connection
5-8, 10	GND	N/A	Signal ground
9	VCC	N/A	Vcc
11	NC	N/A	No connection
12	DDC data out	O	Monitor detect data

13	HSYNC	O	Horizontal synchronization
14	VSYNC	O	Vertical synchronization
15	NC	N/A	No connection

USB Connectors

The system's USB connectors support USB-compliant peripherals such as keyboards, mice, and printers and may also support USB-compliant devices such as diskette drives and optical drives. [Figure B-6](#) illustrates the pin numbers for the USB connector and [Table B-6](#) defines the pin assignments for the connector.

NOTICE: Do not attach a USB device or a combination of USB devices that draw a maximum current of more than 500 mA per channel or +5 V. Attaching devices that exceed this threshold may cause the USB connectors to shut down. See the documentation that accompanied the USB devices for their maximum current ratings.

Figure B-6. USB Connector Pin Numbers



Table B-6. USB Connector Pin Assignments

Pin	Signal	I/O	Definition
1	Vcc	N/A	Supply voltage
2	DATA	I	Data in
3	+DATA	O	Data out
4	GND	N/A	Signal ground

Integrated NIC Connectors

Each of the system's integrated NICs function as a separate network expansion card while providing fast communication between servers and workstations. [Figure B-7](#) illustrates the pin numbers for the NIC connector and [Table B-7](#) defines the pin assignments for the connectors.

Figure B-7. NIC Connector

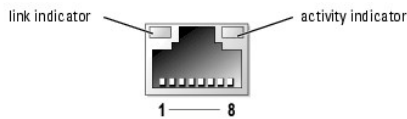



Table B-7. NIC Connector Pin Assignments

Pin	Signal	I/O	Definition
1	TD+	O	Data out (+)
2	TD-	O	Data out (-)
3	RD+	I	Data in (+)
4	NC	N/A	No connection
5	NC	N/A	No connection
6	RD-	I	Data in (-)
7	NC	N/A	No connection
8	NC	N/A	No connection

Network Cable Requirements

The NIC supports a UTP Ethernet cable equipped with a standard RJ45-compatible plug.

Observe the following cabling restrictions.

 **NOTICE:** To avoid line interference, voice and data lines must be in separate sheaths.

- 1 Use Category 5 or greater wiring and connectors.
- 1 Do not exceed a cable run length (from a workstation to a hub) of 100 m (328 ft).

For detailed guidelines on operation of a network, see "Systems Considerations of Multi-Segment Networks" in the IEEE 802.3 standard.

[Back to Contents Page](#)

[Back to Contents Page](#)

Introduction

Dell™ PowerEdge™ 800 Systems Installation and Troubleshooting Guide

[Other Documents You May Need](#)

Your system includes the following service and upgrade features:

- 1 Embedded server management hardware, which monitors temperatures and voltages throughout the system
- 1 System diagnostics, which checks for hardware problems (if the system can boot)

System upgrade options are offered, including:

- 1 Microprocessors
- 1 Additional system memory
- 1 A variety of PCI, PCI-X, and PCIe expansion-card options (including SCSI and SATA RAID controller cards)
- 1 Optional remote access card for remote systems management
- 1 Tape backup units
- 1 Diskette drive
- 1 Additional SATA or SCSI hard drives
- 1 Optional SCSI backplane bay to support up to four front-access non-hot-plug SCSI hard drives (SCSI controller required) or hot-plug SCSI drives (optional SCSI RAID controller required)

Other Documents You May Need

 The *Product Information Guide* provides important safety and regulatory information. Warranty information may be included within this document or as a separate document.

- 1 The *Getting Started Guide* provides an overview of initially setting up your system.
- 1 The *User's Guide* provides information about system features and technical specifications.
- 1 Systems management software documentation describes the features, requirements, installation, and basic operation of the software.
- 1 Operating system documentation describes how to install (if necessary), configure, and use the operating system software.
- 1 Documentation for any components you purchased separately provides information to configure and install these options.
- 1 Updates are sometimes included with the system to describe changes to the system, software, and/or documentation.

 **NOTE:** Always read the updates first because they often supersede information in other documents.

- 1 Release notes or readme files may be included to provide last-minute updates to the system or documentation or advanced technical reference material intended for experienced users or technicians.

[Back to Contents Page](#)

[Back to Contents Page](#)

Indicators, Messages, and Codes

Dell™ PowerEdge™ 800 Systems Installation and Troubleshooting Guide

- [Front-Panel Indicators and Features](#)
- [Back-Panel Features and Indicators](#)
- [SCSI Hard-Drive Indicator Codes](#)
- [Power Indicator Codes](#)
- [NIC Indicator Codes](#)
- [Diagnostics Indicator Codes](#)
- [System Messages](#)
- [System Beep Codes](#)
- [Warning Messages](#)
- [Diagnostics Messages](#)
- [Alert Messages](#)
- [Baseboard Management Controller Messages](#)

The system, applications, and operating systems can identify problems and alert you to them. Any of the following can indicate when the system is not operating properly:

- 1 System indicators
- 1 System messages
- 1 Beep codes
- 1 Warning messages
- 1 Diagnostics messages
- 1 Alert messages

This section describes each type of message, lists the possible causes, and provides steps to resolve any problems indicated by a message. The system indicators and features are illustrated in this section.

Front-Panel Indicators and Features

System Status Indicators

The system front panel incorporates blue and amber system status indicators. The blue indicator lights up when the system is operating correctly. The amber indicator lights up when the system needs attention due to a problem with power supplies, fans, system temperature, or hard drives.

[Table 2-1](#) lists the system's indicator patterns. Different patterns are displayed as events occur in the system.

Table 2-1. System Status Indicator Patterns

Blue and Amber System Status Indicator	Description
Off	Power is not available to the system.
Amber indicator is blinking.	The system has detected an error. See " System Messages " and " Troubleshooting Your System " for more information.
Blue indicator is on. Amber indicator is off	Power is on, and the system is operational.

[Figure 2-1](#) shows the controls, indicators, and connectors located behind the optional bezel on the system's front panel. [Table 2-2](#) describes the front-panel features.

Figure 2-1. Front-Panel Features and Indicators

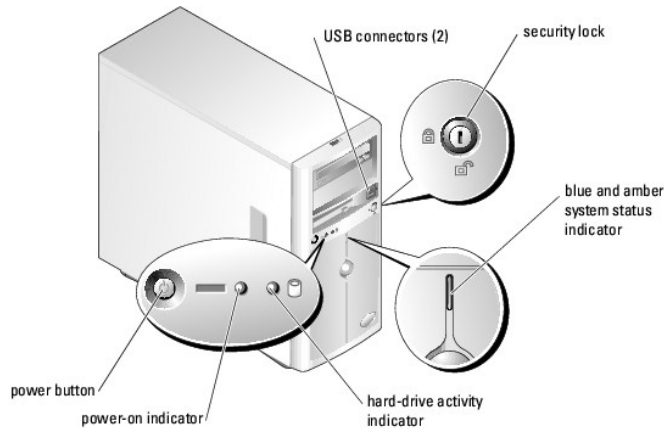

Table 2-2. Front-Panel Indicators, Buttons, and Connectors

Indicator, Button, or Connector	Description
Blue and amber system status indicator	The blue system status indicator lights during normal system operation. The amber system status indicator flashes when the system needs attention due to a problem with power supplies, fans, system temperature, or hard drives. NOTE: If the system is connected to AC power and an error has been detected, the amber system status indicator flashes regardless of whether the system has been powered on.
Power button	Turns system power off and on. <ul style="list-style-type: none"> 1 If you turn off the system using the power button and the system is running an ACPI-compliant operating system, the system can perform an orderly shutdown before power is turned off. If the power button is pressed for more than 4 seconds, the system power will turn off regardless of the current operating system state. 1 If the system is not running an ACPI-compliant operating system, power is turned off immediately after the power button is pressed. <p>The power button is enabled in the System Setup program. When disabled, the button can only turn the system power on. For more information, see "Using the System Setup Program" in your <i>User's Guide</i>, and the operating system's documentation.</p>
Power-on indicator	The power-on indicator lights when the system power is on. When the indicator is off, the system is off. To exit from a power-saving state, briefly press the power button or click or move the mouse.
Hard-drive activity indicator	Flashes when data is being read from or written to the internal SATA hard drives that are connected to the integrated controller.
USB connectors	Connects USB 2.0-compliant devices to the system.

Back-Panel Features and Indicators

[Figure 2-2](#) shows the controls, indicators, and connectors located on the system's back panel.

Figure 2-2. Back-Panel Features and Indicators

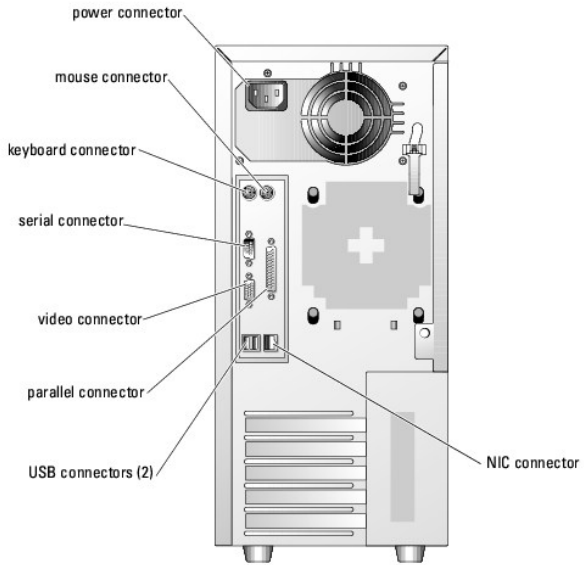

SCSI Hard-Drive Indicator Codes

If an optional SCSI RAID controller is installed in the system, two indicators on each of the hard-drive carriers provide information on the status of the SCSI hard drives. See [Figure 2-3](#) and [Table 2-3](#). The SCSI backplane firmware controls the drive power-on/fault indicator.

Figure 2-3. SCSI Hard-Drive Indicators

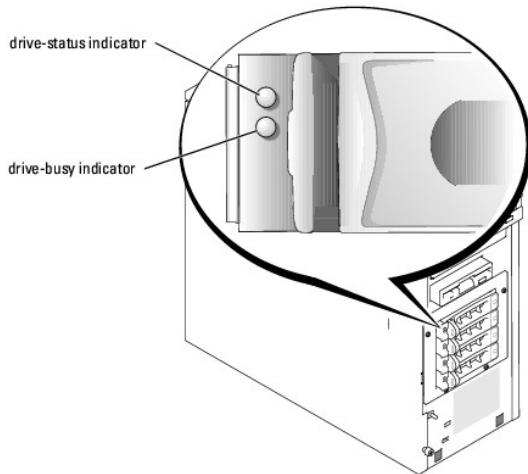

[Table 2-3](#) lists the drive indicator patterns. Different patterns are displayed as drive events occur in the system. For example, if a hard drive fails, the "drive failed" pattern appears. After the drive is selected for removal, the "drive being prepared for removal" pattern appears, followed by the "drive ready for insertion or removal" pattern. After the replacement drive is installed, the "drive being prepared for operation" pattern appears, followed by the "drive online" pattern.

NOTE: If a RAID controller is not installed, only the "drive online" indicator pattern appears. The drive-activity indicator also blinks when the drive is being accessed.

Table 2-3. Hard-Drive Indicator Patterns

Condition	Indicator Pattern
Identify drive	The green power-on/fault indicator blinks four times per second.
Drive being prepared for removal	The green power-on/fault indicator blinks two times per second.
Drive ready for insertion or removal	Both drive indicators are off.
Drive being prepared for operation	The green power-on/fault indicator is on.

Drive predicted failure	The power-on/fault indicator slowly blinks green, amber, and off.
Drive failed	The amber power-on/fault indicator blinks four times per second.
Drive rebuilding	The green power-on/fault indicator blinks slowly.
Drive online	The green power-on/fault indicator is on.

Power Indicator Codes

The power button on the front panel controls the power input to the system's power supplies. The power indicator can provide information on power status (see [Figure 2-1](#)). [Table 2-4](#) lists the power button indicator codes.

Table 2-4. Power Button Indicators

Indicator	Function
On	Indicates that power is supplied to the system and the system is operational.
Off	Indicates that no power is supplied to the system.
Blinking	Indicates that power is supplied to the system, but the system is in a standby state. For information on standby states, see your operating system documentation.

NIC Indicator Codes

Figure 2-4. NIC Indicators

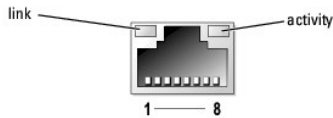

Table 2-5. NIC Indicators









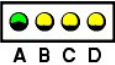

Link indicator	Activity indicator	Description
Off	Off	The NIC is not connected to the network or the NIC is disabled in the System Setup screen. See "Using the System Setup Program" in your <i>User's Guide</i> .
Green	Off	Indicates that the network adapter is connected to a valid link partner on the network, but data is not currently being sent or received.
Green	Blinking amber	Indicates that network data is being sent or received.

Diagnostics Indicator Codes

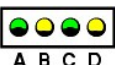
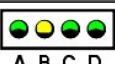
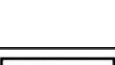
The four diagnostics indicators on the system front panel display error codes during system startup. [Table 2-6](#) details the conditions associated with the diagnostic indicator codes.

Table 2-6. Diagnostic Indicator Codes

Code	Causes	Corrective Action
 A B C D	A possible processor failure has occurred.	See " Troubleshooting the Microprocessor " in "Troubleshooting Your System."
 A B C D	Memory failure.	See " Troubleshooting System Memory " in "Troubleshooting Your System."
 A B C D	Possible expansion-card failure.	See " Troubleshooting Expansion Cards " in "Troubleshooting Your System."
 A B C D	Possible video card failure.	See " Troubleshooting Expansion Cards " in "Troubleshooting Your System."

 A B C D	Diskette or hard-drive failure.	Ensure that the diskette drive and hard drive(s) are properly connected. See " Installing Drives " for information on the drive(s) installed in your system.
 A B C D	Possible USB failure.	See " Troubleshooting a USB Device " in "Troubleshooting Your System."
 A B C D	No memory modules detected.	See " Troubleshooting System Memory " in "Troubleshooting Your System."
 A B C D	System board failure.	See " Getting Help ."
 A B C D	Memory configuration error.	See " Troubleshooting System Memory " in "Troubleshooting Your System."
 A B C D	Possible system board resource and/or system board hardware failure.	See " I/O Assignment Conflicts " in "Finding Software Solutions." If the problem persists, see " Getting Help ."
 A B C D	Possible expansion card failure.	See " Troubleshooting Expansion Cards " in "Troubleshooting Your System."
 A B C D	Other failure.	Ensure that the diskette drive, optical drive, and hard drive(s) are properly connected. See " Troubleshooting Your System " for the appropriate drive(s) installed in your system. If the problem persists, see " Getting Help ."
 A B C D	The system is in a normal operating condition after POST.	Information only.
 = yellow  = green  = off		

System Messages

System messages appear on the screen during system boot to notify you of a possible problem with the system. [Table 2-7](#) lists the system messages that can occur and the probable cause and corrective action for each message.

NOTE: If you receive a system message that is not listed in [Table 2-7](#), check the documentation for the application that is running when the message appears or the operating system's documentation for an explanation of the message and recommended action.

Table 2-7. System Messages

Message	Causes	Corrective Actions
Amount of available memory limited to 256MB!	OS Install Mode is enabled in the System Setup program.	Disable OS Install Mode in the System Setup program. See "Using the System Setup Program" in your <i>User's Guide</i> .
Attempting to update Remote Configuration. Please wait....	Remote Configuration is in progress.	Wait until the process is complete.
BIOS Update Attempt Failed	BIOS remote update failed.	Retry update.
Caution! NVRAM_CLR jumper is installed on system board.	NVRAM_CLR jumper is installed.	Remove the NVRAM_CLR jumper. See Figure A-2 for the jumper location.
CD-ROM drive not found	Improperly connected or missing optical drive.	If no optical drive is installed, disable the IDE controller. See "Using the System Setup Program" in your <i>User's Guide</i> . If an optical drive is installed, see " Troubleshooting an Optical Drive " in "Troubleshooting Your System."
Decreasing available memory	Faulty or improperly installed memory modules.	Ensure that all memory modules are properly installed. See " Troubleshooting System Memory " in "Troubleshooting Your System."
Diskette drive 0 seek failure	Incorrect configuration settings in System Setup program.	Run the System Setup program to correct the settings. See "Using the System Setup Program" in your <i>User's Guide</i> .
	Faulty or improperly installed diskette, loose diskette drive	Replace the diskette. Ensure that the diskette drive and optical drive cables are properly connected. See " Troubleshooting a Diskette Drive " and

	or optical drive interface cable, or loose power cable.	" Troubleshooting an Optical Drive " in "Troubleshooting Your System."
Diskette read failure	Faulty or improperly inserted diskette.	Replace the diskette.
Diskette subsystem reset failed	Faulty diskette drive or optical drive controller.	Ensure that the diskette drive and optical drive cables are properly connected. See " Troubleshooting a Diskette Drive " and " Troubleshooting an Optical Drive " in "Troubleshooting Your System." If the problem persists, see " Getting Help ."
Drive not ready	Diskette missing or improperly inserted in diskette drive.	Reinsert or replace the diskette.
Dual rank DIMMs are not supported in the following memory sockets in this memory configuration.	Invalid memory configuration.	Correct the memory configuration. See " General Memory Module Installation Guidelines " in "Installing System Components."
Error: Incorrect memory configuration. Ensure memory in slots DIMM1_A and DIMM1_B, DIMM2_A and DIMM2_B match identically in size, speed, and rank.	An unmatched pair of memory modules is installed.	Install a matched pair of memory modules, or remove the memory module in socket DIMM1_B. See " General Memory Module Installation Guidelines " in "Installing System Components."
Error: Remote Access Card initialization failure.	Faulty or improperly installed RAC.	Ensure that the RAC is properly installed. See " Troubleshooting Expansion Cards " in "Troubleshooting Your System," or " Installing a RAC Card " in "Installing System Components."
Error 8602: Auxiliary device failure. Verify that the keyboard and mouse are securely attached to correct connectors.	Loose or improperly connected mouse or keyboard cable; faulty mouse or keyboard.	Replace the mouse. If the problem persists, replace the keyboard.
Gate A20 failure	Faulty keyboard controller (faulty system board).	See " Getting Help ."
General failure	Operating system corrupted or improperly installed.	Reinstall the operating system.
IDE Primary drive 1 not found	Improperly connected or missing optical drive or tape backup unit.	Ensure that the drive cables are properly connected. See " Troubleshooting Your System " for the appropriate drive installed in your system. If no drive is installed, disable the IDE controller. See "Using the System Setup Program" in your <i>User's Guide</i> .
Keyboard controller failure	Faulty keyboard controller (faulty system board).	See " Getting Help ."
Keyboard data line failure Keyboard failure Keyboard stuck key failure	Loose or improperly connected keyboard cable; faulty keyboard; faulty keyboard controller.	Ensure that the keyboard is properly connected. If the problem persists, replace the keyboard. If the problem persists, see " Getting Help ."
Keyboard fuse has failed.	Keyboard fuse has failed.	Replace the keyboard. Faulty system board. See " Getting Help ."
Manufacturing mode detected	System is incorrectly configured.	After the message appears during system boot, press <Alt><F> to turn off manufacturing mode.
Memory address line failure at address, read value expecting value Memory double word logic failure at address, read value expecting value Memory odd/even logic failure at start address to end address Memory write/read failure at address, read value expecting value	Faulty or improperly installed memory modules, or faulty system board.	Ensure that all memory modules are properly installed. See " Troubleshooting System Memory " in "Troubleshooting Your System." If the problem persists, see " Getting Help ."
Memory tests terminated by keystroke	The spacebar was pressed during POST to terminate the memory test.	Information only.
No boot device available	Faulty or missing diskette drive, optical drive, or hard drive.	Check the Integrated Devices configuration settings in the System Setup program. See "Using the System Setup Program" in your <i>User's Guide</i> . Ensure that either SATA Controller , Diskette Controller , or IDE Controller is enabled. If the system is booting from a SCSI controller, ensure that the controller is properly connected. If the problem persists, replace the drive. See " Installing Drives ."
No boot sector on hard-disk drive	An operating system is not on the hard drive.	Check the hard-drive configuration settings in the System Setup program. See "Using the System Setup Program" in your <i>User's Guide</i> .
No timer tick interrupt	Faulty system board.	See " Getting Help ."
Not a boot diskette	Not a bootable diskette.	Use a bootable diskette.
PCI BIOS failed to install	Loose cables to expansion card(s); faulty or improperly installed expansion card.	Ensure that all appropriate cables are securely connected to the expansion cards. See " Troubleshooting Expansion Cards " in "Troubleshooting Your System."
PCIe Degraded Link Width Error: Embedded Bus#nn/Dev#nn/Funcn Expected Link Width is n	Faulty or improperly installed PCIe card.	Reseat the PCIe cards. See " Expansion Cards ." If the problem persists, see " Getting Help ."

Actual Link Width is <i>n</i>		
PCIe Degraded Link Width Error: Slot <i>n</i> Expected Link Width is <i>n</i> Actual Link Width is <i>n</i>	Faulty or improperly installed PCIe card in the specified slot number.	Reseat the PCIe card in the specified slot number. See " Expansion Cards ." If the problem persists, see " Getting Help ."
PCIe Training Error: Embedded Bus# <i>nn</i> /Dev# <i>nn</i> /Func <i>n</i>	Faulty or improperly installed PCIe card.	Reseat the PCIe cards. See " Expansion Cards ." If the problem persists, see " Getting Help ."
PCIe Training Error: Slot <i>n</i>	Faulty or improperly installed PCIe card in the specified slot number.	Reseat the PCIe card in the specified slot number. See " Expansion Cards ." If the problem persists, see " Getting Help ."
Plug & Play Configuration Error	Error encountered in initializing PCI device; faulty system board.	Install the NVRAM_CLR jumper and reboot the system. See Figure A-2 for jumper location. Check for a BIOS update. If the problem persists, see " Troubleshooting Expansion Cards " in "Troubleshooting Your System." If the problem persists, see " Getting Help ."
Read fault Requested sector not found	Faulty diskette, diskette drive, optical drive, or hard drive.	Replace the diskette. Ensure that the diskette, optical, and hard-drive cables are properly connected. See " Troubleshooting a Diskette Drive ," " Troubleshooting an Optical Drive ," " Troubleshooting SATA Hard Drives ," or " Troubleshooting SCSI Hard Drives " in "Troubleshooting Your System" for the appropriate drive(s) installed in your system.
Remote Configuration update attempt failed	System could not implement Remote Configuration request.	Retry Remote Configuration.
ROM bad checksum = <i>address</i>	Faulty or improperly installed expansion card.	Remove and reseat the expansion cards. See " Troubleshooting Expansion Cards " in "Troubleshooting Your System."
SATA Port <i>n</i> hard disk not found	SATA hard drive not connected to port <i>n</i> .	Ensure that the hard-drive cable is properly connected. See " Cabled SATA and SCSI Hard Drives " in "Installing Drives." If a drive is not connected to port <i>n</i> , check that the SATA port is disabled in the System Setup program. See "Using the System Setup Program" in your <i>User's Guide</i> .
Sector not found Seek error Seek operation failed	Faulty diskette or hard drive.	Replace the diskette. If the problem persists, see " Troubleshooting SATA Hard Drives " or " Troubleshooting SCSI Hard Drives " in "Troubleshooting Your System" for the appropriate drive installed in your system.
Shutdown failure	Shutdown test failure.	Ensure that all memory modules are properly installed. See " Troubleshooting System Memory " in "Troubleshooting Your System." If the problem persists, see " Getting Help ."
The amount of system memory has changed.	Faulty memory module. Information only, if you have changed the memory configuration.	See " Troubleshooting System Memory " in "Troubleshooting Your System." If the problem persists, see " Getting Help ."
The amount of tested memory is below the minimum system configuration. System halted!	Invalid memory configuration or faulty memory module.	See " General Memory Module Installation Guidelines " in "Installing System Components." See " Troubleshooting System Memory " in "Troubleshooting Your System." If the problem persists, see " Getting Help ."
Time-of-day clock stopped	Faulty battery; faulty system board.	See " Troubleshooting the System Battery " in "Troubleshooting Your System." If the problem persists, see " Getting Help ."
Time-of-day not set - please run SETUP program	Incorrect Time or Date settings; faulty system battery.	Check the Time and Date settings See "Using the System Setup Program" in your <i>User's Guide</i> . If the problem persists, see " Troubleshooting the System Battery " in "Troubleshooting Your System."
Timer chip counter 2 failed	Faulty system board.	See " Getting Help ."
Unexpected interrupt in protected mode	Faulty or improperly installed memory modules or faulty system board.	Ensure that all memory modules are properly installed. See " General Memory Module Installation Guidelines " in "Installing System Components." If the problem persists, see " Troubleshooting System Memory " in "Troubleshooting Your System." If the problem persists, see " Getting Help ."
Unsupported CPU stepping detected	Processor is not supported by the system.	Check for a BIOS update using the Dell Support website at support.dell.com . If the problem persists, install a supported processor. See " Installing a Processor " in "Installing System Components."
Utility partition not available	<F10> key was pressed during POST, but no utility partition exists on the boot hard drive.	Create a utility partition on the boot hard drive. See "Using the Dell OpenManage Server Assistant CD" in your <i>User's Guide</i> .
Warning! No microcode update loaded for processor <i>n</i>	Unsupported processor.	Update the BIOS firmware using the Dell Support website at support.dell.com .
Write fault Write fault on selected drive	Faulty diskette, diskette drive, optical drive, hard drive.	Replace the diskette. Ensure that the diskette drive, optical drive, and hard-drive cables are properly connected. See " Troubleshooting a Diskette Drive ," " Troubleshooting an Optical Drive ," or " Troubleshooting SCSI Hard Drives " in "Troubleshooting Your System" for the appropriate drive(s) installed in your system.

System Beep Codes

If an error that cannot be reported on the screen occurs during POST, the system may emit a series of beeps that identifies the problem.

 **NOTE:** If the system boots without a keyboard, mouse, or monitor attached, the system does not issue beep codes related to those peripherals.

If a beep code is emitted, write down the series of beeps and then look it up in [Table 2-8](#). If you are unable to resolve the problem by looking up the meaning of the beep code, use system diagnostics to identify the possible cause. If you are still unable to resolve the problem, see ["Getting Help."](#)

Table 2-8. System Beep Codes

Code	Cause	Corrective Action
1-1-2	CPU register test failure	See " Troubleshooting the Microprocessor " in "Troubleshooting Your System."
1-1-3	CMOS write/read failure; faulty system board	Faulty system board. See " Getting Help ."
1-1-4	BIOS error	Reflash the BIOS.
1-2-1	Programmable interval-timer failure; faulty system board	Faulty system board. See " Getting Help ."
1-2-2	DMA initialization failure	See " Troubleshooting System Memory " in "Troubleshooting Your System."
1-2-3	DMA page register write/read failure	
1-3-1	Main-memory refresh verification failure	
1-3-2	No memory installed	
1-3-3	Chip or data line failure in the first 64 KB of main memory	
1-3-4	Odd/even logic failure in the first 64 KB of main memory	
1-4-1	Address line failure in the first 64 KB of main memory	
1-4-2	Parity failure in the first 64 KB of main memory	
1-4-3	Fail-safe timer test failure	
1-4-4	Software NMI port test failure	
2-1-1 through 2-4-4	Bit failure in the first 64 KB of main memory	
3-1-1	Slave DMA-register failure	Faulty system board. See " Getting Help ."
3-1-2	Master DMA-register failure	
3-1-3	Master interrupt-mask register failure	
3-1-4	Slave interrupt-mask register failure	
3-2-2	Interrupt vector loading failure	
3-2-4	Keyboard-controller test failure	
3-3-1	CMOS failure	
3-3-2	System configuration check failure	
3-3-3	Keyboard controller not detected	
3-3-4	Video memory test failure	
3-4-1	Screen initialization failure	
3-4-2	Screen-retrace test failure	
3-4-3	Video ROM search failure	
4-2-1	No timer tick	Faulty system board. See " Getting Help ."
4-2-2	Shutdown test failure	
4-2-3	Gate A20 failure	
4-2-4	Unexpected interrupt in protected mode	See " Troubleshooting Expansion Cards " in "Troubleshooting Your System."
4-3-1	Improperly installed or faulty memory modules	See " Troubleshooting System Memory " in "Troubleshooting Your System."
4-3-2	No memory modules installed in the first memory module connector	Install a memory module in the first memory module connector. See " System Memory " in "Installing System Components."
4-3-3	Faulty system board	Faulty system board. See " Getting Help ."
4-3-4	Time-of-day clock stopped	See " Troubleshooting System Memory " in "Troubleshooting Your System." If the problem persists, see " Getting Help ."
4-4-1	Super I/O chip failure; faulty system board	Faulty system board. See " Getting Help ."
4-4-4	Cache test failure; faulty processor	See " Troubleshooting the Microprocessor " in "Troubleshooting Your System."

Warning Messages

A warning message alerts you to a possible problem and prompts you to respond before the system continues a task. For example, before you format a diskette, a message will warn you that you may lose all data on the diskette. Warning messages usually interrupt the task and require you to respond by typing y (yes) or n (no).

 **NOTE:** Warning messages are generated by either the application or the operating system. For more information, see "[Finding Software Solutions](#)" and the documentation that accompanied the operating system or application.

Diagnostics Messages

When you run system diagnostics, an error message may result. Diagnostic error messages are not covered in this section. Record the message on a copy of the Diagnostics Checklist in "Getting Help," and then follow the instructions in that section for obtaining technical assistance.

Alert Messages

Systems management software generates alert messages for your system. Alert messages include information, status, warning, and failure messages for drive, temperature, fan, and power conditions. For more information, see the systems management software documentation.

Baseboard Management Controller Messages

The Baseboard Management Controller (BMC) enables you to configure, monitor, and recover systems remotely. BMC uses the system's serial port and integrated NIC1 to support fault logging and SNMP alerting.

 **NOTE:** If the integrated network controller is used in an Ether Channel team or link aggregation team, the BMC management traffic will not function properly. For more information about network teaming, see the documentation for the network controller.

For additional information on using BMC, see the documentation for the BMC and systems management applications.

[Back to Contents Page](#)

[Back to Contents Page](#)

Finding Software Solutions

Dell™ PowerEdge™ 800 Systems Installation and Troubleshooting Guide

- [Before You Begin](#)
- [Troubleshooting Errors and Conflicts](#)

Software problems can be caused by:

- 1 Improper installation or configuration of an application
- 1 Application conflicts
- 1 Input errors
- 1 Interrupt assignment conflicts

Ensure that you are installing the software application according to the software manufacturer's recommended procedures. If a problem occurs after you install the software, you might need to troubleshoot your software application and your system.

See the documentation that accompanied the software or contact the software manufacturer for detailed troubleshooting information.

 **NOTE:** If all of the system diagnostic tests complete successfully, then the problem is most likely caused by the software and not the hardware.

Before You Begin

- 1 Scan the software media with antivirus software.
- 1 Read the software documentation before you run the installation utility.
- 1 Be prepared to respond to prompts from the installation utility.

The installation utility may require you to enter information about your system, such as how the operating system is configured, and the type of peripherals that are connected to the system. Have this information available before running the installation utility.

Troubleshooting Errors and Conflicts

While configuring and running software, problems might occur that are caused by input errors, application conflicts, and/or IRQ assignment conflicts. The problems are sometimes indicated by error messages.

Error messages are generated by system hardware or software. "[Indicators, Messages, and Codes](#)" provides information about error messages that are hardware-based. If you receive an error message that is not listed, see your operating system or software program documentation for troubleshooting information.

Input Errors

Pressing a specific key or set of keys at the wrong time may produce unexpected results. See the documentation that came with the software application to ensure that the values or characters you are entering are valid.

Ensure that your operating system is configured properly to run the application. Remember that whenever you change the parameters of the operating system, the changes can conflict with an application's operating requirements. After you configure the operating system, you may need to reinstall or reconfigure a software application so that it can run properly in its new environment.

Application Conflicts

Some applications can leave unnecessary files or data behind after they are deleted from your system. Device drivers can also create application errors. If application errors occur, see your application device driver or operating system documentation for troubleshooting information.

IRQ Assignment Conflicts

Most PCI devices can share an IRQ, but they cannot use an IRQ simultaneously. To avoid this type of conflict, see the documentation for each PCI device for specific IRQ requirements.

Table 3-1. IRQ Assignment Defaults

IRQ Line	Assignment
IRQ0	System timer
IRQ1	Keyboard controller

IRQ2	Interrupt controller 1 to enable IRQ8 through IRQ15
IRQ3	<i>Available</i>
IRQ4	Serial port 1 (COM1 and COM3)
IRQ5	Remote access controller
IRQ6	Diskette drive controller
IRQ7	Parallel port
IRQ8	Real-time clock
IRQ9	ACPI functions (used for power management)
IRQ10	<i>Available</i>
IRQ11	<i>Available</i>
IRQ12	PS/2 mouse port unless the mouse is disabled through the System Setup program
IRQ13	Math coprocessor
IRQ14	IDE optical drive controller
IRQ15	<i>Available</i>

[Back to Contents Page](#)

[Back to Contents Page](#)

Running the System Diagnostics

Dell™ PowerEdge™ 800 Systems Installation and Troubleshooting Guide

- [Using Server Administrator Diagnostics](#)
- [System Diagnostics Features](#)
- [When to Use the System Diagnostics](#)
- [Running the System Diagnostics](#)
- [System Diagnostics Testing Options](#)
- [Using the Custom Test Options](#)

If you experience a problem with your system, run the diagnostics before calling for technical assistance. The purpose of the diagnostics is to test your system's hardware without requiring additional equipment or risking data loss. If you are unable to fix the problem yourself, service and support personnel can use diagnostics test results to help you solve the problem.

Using Server Administrator Diagnostics

To assess a system problem, first use the online Server Administrator diagnostics. If you are unable to identify the problem, then use the system diagnostics.

To access the online diagnostics, log into the Server Administrator home page, and then click the **Diagnostics** tab. For information about using diagnostics, see the online help. For additional information, see the *Server Administrator User's Guide*.

System Diagnostics Features

The system diagnostics provides a series of menus and options for particular device groups or devices. The system diagnostics menus and options allow you to:

- 1 Run tests individually or collectively.
 - 1 Control the sequence of tests.
 - 1 Repeat tests.
 - 1 Display, print, or save test results.
 - 1 Temporarily suspend testing if an error is detected or terminate testing when a user-defined error limit is reached.
 - 1 View help messages that briefly describe each test and its parameters.
 - 1 View status messages that inform you if tests are completed successfully.
 - 1 View error messages that inform you of problems encountered during testing.
-

When to Use the System Diagnostics

If a major component or device in the system does not operate properly, component failure may be indicated. As long as the microprocessor and the system's input/output devices (monitor, keyboard, and diskette drive) are functioning, you can use the system diagnostics to help identify the problem.

Running the System Diagnostics

The system diagnostics is run from the utility partition on your hard drive.

 **NOTICE:** Use the system diagnostics to test only your system. Using this program with other systems may cause invalid results or error messages. In addition, use only the program that came with your system (or an updated version of that program).

1. As the system boots, press <F10> during POST.
2. From the utility partition main menu, select **Run System Diagnostics**, or select **Run Memory Diagnostics** if you are troubleshooting memory.

When you start the system diagnostics, a message is displayed stating that the diagnostics are initializing. Next, the **Diagnostics** menu appears. The menu allows you to run all or specific diagnostics tests or to exit the system diagnostics.

 **NOTE:** Before you read the rest of this section, start the system diagnostics so that you can see the utility on your screen.

System Diagnostics Testing Options

Click the testing option in the **Main Menu** window. [Table 4-1](#) provides a brief explanation of testing options.

Table 4-1. System Diagnostics Testing Options

Testing Option	Function
Express Test	Performs a quick check of the system. This option runs device tests that do not require user interaction. Use this option to quickly identify the source of your problem.
Extended Test	Performs a more thorough check of the system. This test can take an hour or longer.
Custom Test	Tests a particular device.
Information	Displays test results.

Using the Custom Test Options

When you select **Custom Test** in the **Main Menu** window, the **Customize** window appears and allows you to select the device(s) to be tested, select specific options for testing, and view the test results.

Selecting Devices for Testing

The left side of the **Customize** window lists devices that can be tested. Devices are grouped by device type or by module, depending on the option you select. Click the **(+)** next to a device or module to view its components. Click **(+)** on any component to view the tests that are available. Clicking a device, rather than its components, selects all of the components of the device for testing.

Selecting Diagnostics Options

Use the **Diagnostics Options** area to select how you want to test a device. You can set the following options:

- 1 **Non-Interactive Tests Only** — When checked, runs only tests that require no user intervention.
- 1 **Quick Tests Only** — When checked, runs only the quick tests on the device. Extended tests will not run when you select this option.
- 1 **Show Ending Timestamp** — When checked, time stamps the test log.
- 1 **Test Iterations** — Selects the number of times the test is run.
- 1 **Log output file pathname** — When checked, enables you to specify where the test log file is saved.

Viewing Information and Results

The tabs in the **Customize** window provide information about the test and the test results. The following tabs are available:

- 1 **Results** — Displays the test that ran and the result.
- 1 **Errors** — Displays any errors that occurred during the test.
- 1 **Help** — Displays information about the currently selected device, component, or test.
- 1 **Configuration** — Displays basic configuration information about the currently selected device.
- 1 **Parameters** — If applicable, displays parameters that you can set for the test.

[Back to Contents Page](#)

Troubleshooting Your System

Dell™ PowerEdge™ 800 Systems Installation and Troubleshooting Guide

- [Safety First—For You and Your System](#)
- [Start-Up Routine](#)
- [Checking Basic Power Problems](#)
- [Checking the Equipment](#)
- [Troubleshooting Basic I/O Functions](#)
- [Troubleshooting a NIC](#)
- [Responding to a Systems Management Software Alert Message](#)
- [Opening the System](#)
- [Closing the System](#)
- [Inside the System](#)
- [Troubleshooting a Wet System](#)
- [Troubleshooting a Damaged System](#)
- [Troubleshooting the System Battery](#)
- [Troubleshooting a Power Supply](#)
- [Troubleshooting System Cooling Problems](#)
- [Troubleshooting System Memory](#)
- [Troubleshooting a Diskette Drive](#)
- [Troubleshooting an Optical Drive](#)
- [Troubleshooting a SCSI Tape Drive](#)
- [Troubleshooting SCSI Hard Drives](#)
- [Troubleshooting SATA Hard Drives](#)
- [Troubleshooting a RAID Controller Card](#)
- [Troubleshooting Expansion Cards](#)
- [Troubleshooting the Microprocessor](#)

Safety First—For You and Your System

To perform certain procedures in this document, you must remove the system cover and work inside the system. While working inside the system, do not attempt to service the system except as explained in this guide and elsewhere in your system documentation.

 **CAUTION:** See your *Product Information Guide* for complete information about safety precautions, working inside the computer, and protecting against electrostatic discharge.

Start-Up Routine

Look and listen during the system's start-up routine for the indications described in [Table 5-1](#).

Table 5-1. Start-Up Routine Indications

Look/listen for:	Action
An error message displayed on the monitor.	See " System Messages " in "Indicators, Codes, and Messages."
A series of beeps emitted by the system.	See " System Beep Codes " in "Indicators, Codes, and Messages."
Alert messages from the systems management software.	See the systems management software documentation.
The monitor's power indicator.	See " Troubleshooting the Video Subsystem ."
The keyboard indicators.	See " Troubleshooting the Keyboard ."
The diskette drive activity indicator.	See " Troubleshooting a Diskette Drive ."
The optical drive activity indicator.	See " Troubleshooting an Optical Drive ."
The hard-drive activity indicator.	See " Troubleshooting SCSI Hard Drives ."
An unfamiliar constant scraping or grinding sound when you access a drive.	See " Getting Help ."

Checking Basic Power Problems

1. If the power indicator on the system front panel or power supply does not indicate that power is available to the system, ensure that the power cable is securely connected to the power supply.
2. If the system is connected to a PDU or UPS, turn the PDU or UPS off and then on.
3. If the PDU or UPS is not receiving power, plug it into another electrical outlet. If it still is not receiving power, try another PDU or UPS.
4. Reconnect the system to the electrical outlet and turn on the system.

If the system still is not working properly, see "[Troubleshooting a Power Supply](#)."

Checking the Equipment

This section provides troubleshooting procedures for external devices attached to the system, such as the monitor, keyboard, or mouse. Before you perform

any of the procedures, see "[Troubleshooting External Connections](#)."

Troubleshooting External Connections

Loose or improperly connected cables are the most likely source of problems for the system, monitor, and other peripherals (such as a printer, keyboard, mouse, or other external device). Ensure that all external cables are securely attached to the external connectors on your system. See [Figure 2-1](#) and [Figure 2-2](#) for the front-panel and back-panel connectors on your system.

Troubleshooting the Video Subsystem

Problem

- 1 Monitor is not working properly.
- 1 Video memory is faulty.

Action

1. Check the system and power connections to the monitor.
2. Run the appropriate online diagnostic test. See "[Using Server Administrator Diagnostics](#)" in "Running System Diagnostics."

If the tests run successfully, the problem is not related to video hardware. See "[Finding Software Solutions](#)."

If the tests fail, see "[Getting Help](#)."

Troubleshooting the Keyboard

Problem

- 1 System message indicates a problem with the keyboard.
- 1 Keyboard is not functioning properly.

Action

1. Run the appropriate online diagnostic test. See "[Using Server Administrator Diagnostics](#)" in "Running System Diagnostics."
2. Examine the keyboard and its cable for signs of damage.
3. Swap the faulty keyboard with a working keyboard.

If the problem is resolved, replace the faulty keyboard.

4. If the keyboard is a USB keyboard, enter the System Setup program and ensure that the USB ports are enabled. See "Using the System Setup Program" in your *User's Guide*.

If the problem is not resolved, see "[Getting Help](#)."

Troubleshooting the Mouse

Problem

- 1 System message indicates a problem with the mouse.
- 1 Mouse is not functioning properly.

Action

1. Run the appropriate online diagnostic test. See "[Using Server Administrator Diagnostics](#)" in "Running System Diagnostics."
If the test fails, continue to the next step.
 2. Examine the mouse and its cable for signs of damage.
If the mouse is not damaged, go to [step 5](#).
If the mouse is damaged, continue to the next step.
 3. Swap the faulty mouse with a working mouse.
If the problem is resolved, replace the faulty mouse.
 4. If the mouse is a USB mouse, enter the System Setup program and ensure that the USB ports are enabled. See "Using the System Setup Program" in your *User's Guide*.
 5. If the problem is not resolved, see "[Getting Help](#)."
-

Troubleshooting Basic I/O Functions

Problem

1. Error message indicates a problem with the serial port.
1. Device connected to the serial port is not operating properly.

Action

1. Enter the System Setup program and ensure that the serial port is enabled, and that console redirection is disabled. See "Using the System Setup Program" in your *User's Guide*.
2. If the problem is confined to a particular application, see the application documentation for specific port configuration requirements that the program may require.
3. Run the appropriate online diagnostic test. See "[Using Server Administrator Diagnostics](#)" in "Running System Diagnostics."
If the tests run successfully but the problem persists, see the appropriate procedure—"Troubleshooting a Serial I/O Device" or "[Troubleshooting a Non-USB Parallel Printer](#)."

Troubleshooting a Serial I/O Device

Problem

1. Device connected to the serial port is not operating properly.

Action

1. Turn off the system and any peripheral devices connected to the serial port.
2. Swap the serial interface cable with a working cable, and turn on the system and the serial device.
If the problem is resolved, replace the interface cable.
3. Turn off the system and the serial device, and swap the device with a comparable device.
4. Turn on the system and the serial device.
If the problem is resolved, replace the serial device.
If the problem persists, see "[Getting Help](#)."

Troubleshooting a USB Device

Problem

- 1 System message indicates a problem with a USB device.
- 1 Device connected to a USB port is not operating properly.

Action

1. Enter the System Setup program, and ensure that the USB ports are enabled. See "Using the System Setup Program" in your *User's Guide*.
2. Turn off the system and any USB devices.
3. Disconnect the USB devices, and connect the malfunctioning device to another USB connector.
4. Turn on the system and the reconnected device.
If the problem is resolved, the USB connector might be defective. See "[Getting Help](#)."
5. If possible, swap the interface cable with a working cable.
If the problem is resolved, replace the interface cable.
6. Turn off the system and the USB device, and swap the device with a comparable device.
7. Turn on the system and the USB device.
If the problem is resolved, replace the USB device.
If the problem persists, see "[Getting Help](#)."

Troubleshooting a Non-USB Parallel Printer

Problem

- 1 Parallel printer is not operating properly.
- 1 Parallel printer interface cable is faulty.

Action

1. Turn off the system and the parallel printer.
 2. Swap the parallel printer interface cable with a known working cable, and turn on the system and the printer.
 3. Attempt a print operation.
 4. If the print operation is successful, replace the interface cable (see "[Getting Help](#)").
 5. Run the printer's self-test.
 6. If the self-test fails, the printer is malfunctioning (see "[Getting Help](#)").
-

Troubleshooting a NIC

Problem

- 1 NIC cannot communicate with network.

Action

1. Run the appropriate online diagnostic test. See "[Using Server Administrator Diagnostics](#)" in "Running System Diagnostics."
2. Enter the System Setup program and confirm that the NICs are enabled. See "Using the System Setup Program" in your *User's Guide*.
3. Check the appropriate indicator on the NIC connector. See "[NIC Indicator Codes](#)" in "Indicators, Messages, and Codes."
 1. If the link indicator does not light, check all cable connections.
 1. If the activity indicator does not light, the network driver files might be damaged or missing.
Remove and reinstall the drivers if applicable. See the NIC's documentation.
 1. Use another connector on the switch or hub.

If you are using a NIC card instead of an integrated NIC, see the documentation for the NIC card.

4. Ensure that the appropriate drivers are installed and the protocols are bound. See the NIC's documentation.
5. Ensure that the NICs, hubs, and switches on the network are all set to the same data transmission speed. See the network equipment documentation.
6. Ensure that all network cables are of the proper type and do not exceed the maximum length. See "Network Cable Requirements" in your *User's Guide*.

Responding to a Systems Management Software Alert Message

Systems management software monitors critical system voltages and temperatures, fans, and hard drives in the system. Alert messages appear in the **Alert Log** window. For information about the **Alert Log** window, see the systems management software documentation.

Opening the System

Removing the Bezel

You must remove the bezel to remove the system cover.

1. Using the system key, unlock the bezel. See [Figure 5-1](#).
2. Slide the bezel latch toward the right side of the system.
3. Swing the top of the bezel away from the system, disengage the hooks at the bottom of the bezel, and lift the bezel away from the system.

Figure 5-1. Removing the Bezel

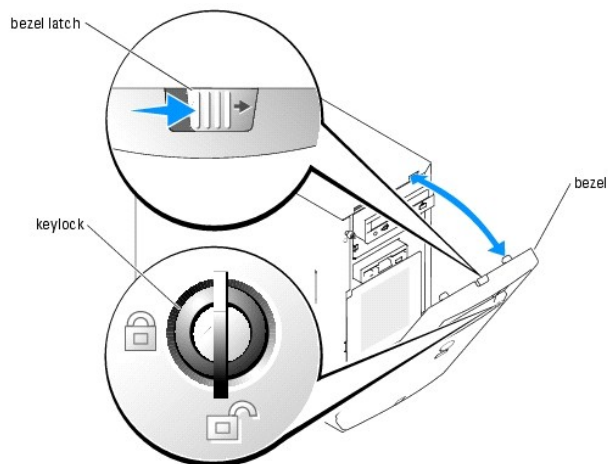

Removing the Cover

To upgrade or troubleshoot the system, remove the system cover to gain access to internal components.

⚠ CAUTION: See your *Product Information Guide* for complete information about safety precautions, working inside the computer, and protecting against electrostatic discharge.

1. Turn off the system and attached peripherals, and disconnect the system from the electrical outlet.
2. Remove the bezel. See "[Removing the Bezel](#)."
3. Lay the system on its right side.
4. Loosen the thumbscrew at the front of the system. See [Figure 5-2](#).
5. Slide the cover forward and grasp it at both ends.
6. Lift the front edge of the cover 2.5 cm (1 inch), slide the cover toward the top of the system, and then lift the cover away from the system.

Figure 5-2. Removing the Cover

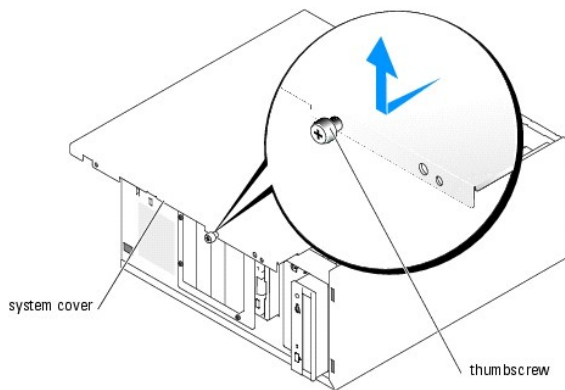

Closing the System

Replacing the Cover

1. Ensure that all cables are connected, and fold cables out of the way.
2. Ensure that no tools or loose parts are left inside the system.
3. Fit the cover on the side of the system, and slide the cover backward.
4. Tighten the cover thumbscrew to secure the cover.

Installing the Bezel

To install the bezel, align the hooks at the bottom of the bezel, swing the top of the bezel toward the system, and press the bezel onto the system until it snaps into place. Using the system key, lock the bezel.

Inside the System

In [Figure 5-3](#), the bezel and system cover are removed to provide an interior view of the system.

Figure 5-3. Inside the System

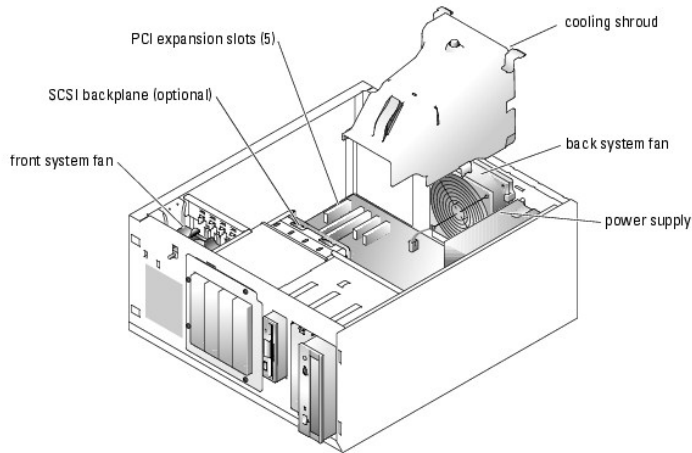

The system board holds the system's control circuitry and other electronic components. The processor and memory are installed directly on the system board. The system can accommodate up to five expansion cards.

The system supports up to four SCSI or SATA hard drives. The peripheral bays support an optional diskette drive and optical drive.

Troubleshooting a Wet System

Problem

- 1 Liquid spilled on the system.
- 1 Excessive humidity.

Action

⚠ CAUTION: See your *Product Information Guide* for complete information about safety precautions, working inside the computer, and protecting against electrostatic discharge.

1. Turn off the system and attached peripherals, and disconnect the system from the electrical outlet.
 2. Open the system. See "[Opening the System](#)."
 3. Remove all expansion cards installed in the system. See "[Removing an Expansion Card](#)" in "Installing System Components."
 4. Remove all memory modules installed in the system. See "[Removing Memory Modules](#)" in "Installing System Components."
 5. Remove the processor from the system. See "[Removing the Processor](#)" in "Installing System Components."
 6. Let the system dry thoroughly for at least 24 hours.
 7. Replace the processor, memory modules, and expansion cards. See "[Installing a Processor](#)," "[Installing Memory Modules](#)," and "[Installing an Expansion Card](#)" in "Installing System Components."
 8. Close the system. See "[Closing the System](#)."
 9. Reconnect the system to the electrical outlet, and turn on the system and peripherals.
If the system does not start properly, see "[Getting Help](#)."
 10. Run the appropriate online diagnostic test. See "[Using Server Administrator Diagnostics](#)" in "Running the System Diagnostics."
If the tests fail, see "[Getting Help](#)."
-

Troubleshooting a Damaged System

Problem

- 1 System was dropped or damaged.

Action

 **CAUTION:** See your *Product Information Guide* for complete information about safety precautions, working inside the computer, and protecting against electrostatic discharge.

1. Open the system. See "[Opening the System](#)."
 2. Ensure that the following components are properly installed:
 - 1 Expansion cards
 - 1 Memory modules
 - 1 Processor
 - 1 Power supplies
 - 1 Fans
 - 1 Hard drives
 3. Ensure that all cables are properly connected.
 4. Close the system. See "[Closing the System](#)."
 5. Run the system board tests in the system diagnostics. See "[Running the System Diagnostics](#)."
If the tests fail, see "[Getting Help](#)."
-

Troubleshooting the System Battery

Problem

- 1 System message indicates a problem with the battery.
- 1 System Setup program loses system configuration information.
- 1 System date and time do not remain current.

 **NOTE:** If the system is turned off for long periods of time (for weeks or months), the NVRAM may lose its system configuration information. This situation is caused by a defective battery.

Action

1. Re-enter the time and date through the System Setup program. See "Using the System Setup Program" in your *User's Guide*.
2. Turn off the system and disconnect it from the electrical outlet for at least one hour.
3. Reconnect the system to the electrical outlet and turn on the system.
4. Enter the System Setup program.
If the date and time are not correct in the System Setup program, replace the battery. See "[System Battery](#)" in "Installing System Components."
If the problem is not resolved by replacing the battery, see "[Getting Help](#)."

 **NOTE:** Some software may cause the system time to speed up or slow down. If the system seems to operate normally except for the time kept in the System Setup program, the problem may be caused by software rather than by a defective battery.

Troubleshooting a Power Supply

Problem

- 1 No power to the system.
- 1 Power indicator on the front panel does not light.

Action

1. Run the appropriate online diagnostics test. See "[Using Server Administrator Diagnostics](#)" in "Running the System Diagnostics."

⚠ CAUTION: See your *Product Information Guide* for complete information about safety precautions, working inside the computer, and protecting against electrostatic discharge.

2. Turn off the system and attached peripherals, and disconnect the system from the electrical outlet.
3. Open the system. See "[Opening the System](#)."
4. Ensure that the power cables are properly connected to the power connectors on the system board and backplane (if installed). To identify the system board power connectors, see [Figure A-3](#).
5. Close the system. See "[Closing the System](#)."
6. Reconnect the system to the electrical outlet, and turn on the system and attached peripherals.

If the problem persists, see "[Getting Help](#)."

Troubleshooting System Cooling Problems

Problem

- 1 A cooling fan is not operating properly.
- 1 System status indicator is amber.
- 1 Systems management software issues a fan-related error message.

Action

⚠ CAUTION: See your *Product Information Guide* for complete information about safety precautions, working inside the computer, and protecting against electrostatic discharge.

1. Run the appropriate diagnostic test. See "[Using Server Administrator Diagnostics](#)" in "Running System Diagnostics."

2. Open the system. See "[Opening the System](#)."

3. Locate the fan referenced by the systems management software or diagnostics.

See [Figure A-3](#) for the relative location of each fan.

Ensure that the fan power cables are securely connected to the fan power connectors on the system board. See [Figure A-3](#) for the location of each fan power connector.

4. Check that cables are not blocking the airflow within the system.
 5. Close the system. See "[Closing the System](#)."
 6. Reconnect the system to the electrical outlet, and turn on the system and attached peripherals.
 7. If the problem is not resolved, install a new fan. See "[System Fans](#)" in "Installing System Components."
 8. If the replacement fan does not operate, see "[Getting Help](#)."
-

Troubleshooting System Memory

Problem

- 1 Faulty memory module.
- 1 Faulty system board.
- 1 System status indicator is amber.
- 1 System beep code indicates a memory problem.
- 1 Systems management software issues a memory-related message through the systems management software.

Action

Memory-related beep code during system startup.

 **CAUTION:** See your *Product Information Guide* for complete information about safety precautions, working inside the computer, and protecting against electrostatic discharge.

1. Turn off the system and attached peripherals, and disconnect the system from the electrical outlet.
2. Open the system. See "[Opening the System](#)."
3. Reseat the memory modules in their sockets. See "[Installing Memory Modules](#)" in "Installing System Components."
4. Close the system. See "[Closing the System](#)."
5. Reconnect the system to the electrical outlet, and turn on the system and attached peripherals.

If there is no memory-related beep code, the problem is resolved.

6. Turn off the system and attached peripherals, and disconnect the system from the electrical outlet.
 - a. Open the system. See "[Opening the System](#)."
 - b. Remove all memory modules from the system. See "[Removing Memory Modules](#)" in "Installing System Components."
 - c. Replace one of the memory modules in socket DIMM1_B.
 - d. Close the system. See "[Closing the System](#)."
 - e. Reconnect the system to the electrical outlet, and turn on the system and attached peripherals.
 - f. If there is no memory-related beep code, the memory module is not faulty.

If the beep code reoccurs, the memory module is faulty and should be replaced.

7. Perform the following steps:
 - a. Turn off the system and attached peripherals, and disconnect the system from its electrical outlet.
 - b. Open the system. See "[Opening the System](#)."
 - c. Repeat [step c](#) through [step f](#) in [step 6](#) for each memory module installed.
8. If you have tested all the memory modules and the problem persists, or none of the memory modules passes, the system board is faulty. See "[Getting Help](#)."

The system starts up successfully but there are memory-related error messages.

 **CAUTION:** See your *Product Information Guide* for complete information about safety precautions, working inside the computer, and protecting against electrostatic discharge.

1. Turn off the system and attached peripherals, and disconnect the system from the electrical outlet.
2. Open the system. See "[Opening the System](#)."

3. Ensure that the memory modules are populated correctly. See "[General Memory Module Installation Guidelines](#)" in "Installing System Components."

If the memory modules are populated correctly, continue to the next step.

4. Reseat the memory modules in their sockets. See "[Installing Memory Modules](#)" in "Installing System Components."

5. Close the system. See "[Closing the System](#)."

6. Reconnect the system to the electrical outlet, and turn on the system and attached peripherals.

If there is no memory-related error message, the problem is resolved.

If the problem persists, see "[Getting Help](#)."

There are memory-related error messages in the SEL.

1. Run the appropriate online diagnostic test. See "[Using Server Administrator Diagnostics](#)" in "Running System Diagnostics."
 2. Replace the memory module(s) identified by the diagnostics. See "[Installing Memory Modules](#)" in "Installing System Components."
 3. Restart the system. If there are still memory-related errors in the SEL, see "[Getting Help](#)."
-

Troubleshooting a Diskette Drive

Problem

1. Error message indicates a problem with the optional diskette drive.

Action

 **CAUTION:** See your *Product Information Guide* for complete information about safety precautions, working inside the computer, and protecting against electrostatic discharge.

1. Enter the System Setup program and verify that the diskette controller is enabled and the diskette drive is configured correctly. See "Using the System Setup Program" in your *User's Guide*.
2. Run the appropriate online diagnostic test. See "[Using Server Administrator Diagnostics](#)" in "Running System Diagnostics."
3. Turn off the system and attached peripherals, and disconnect the system from the electrical outlet.
4. Open the system. See "[Opening the System](#)."
5. Ensure that the diskette drive interface cable is securely connected to the diskette drive and the system board. To identify the connector on the system board, see [Figure A-3](#).
6. Ensure that a power cable is securely connected to the drive.
7. Close the system. See "[Closing the System](#)."
8. Reconnect the system to the electrical outlet, and turn on the system and attached peripherals.
9. Run the appropriate online diagnostic test to see whether the diskette drive works correctly.
If the tests fail, continue to the following step.
10. Turn off the system and attached peripherals, and disconnect the system from its electrical outlet.
11. Open the system. See "[Opening the System](#)."
12. Remove all expansion cards installed in the system. See "[Removing an Expansion Card](#)" in "Installing System Components."
13. Close the system. See "[Closing the System](#)."

14. Reconnect the system to the electrical outlet, and turn on the system and attached peripherals.
 15. Run the appropriate online diagnostic test to see whether the diskette drive works correctly.

If the tests run successfully, an expansion card may be conflicting with the diskette drive logic, or an expansion card may be faulty. Continue to the next step.

If the tests fail, see "[Getting Help](#)."
 16. Turn off the system and attached peripherals, and disconnect the system from the electrical outlet.
 17. Open the system. See "[Opening the System](#)."
 18. Reinstall one of the expansion cards you removed in [step 12](#). See "[Installing an Expansion Card](#)" in "Installing System Components."
 19. Close the system. See "[Closing the System](#)."
 20. Reconnect the system to the electrical outlet, and turn on the system and attached peripherals.
 21. Run the appropriate online diagnostic test to see whether the diskette drive works correctly.
 22. Repeat [step 16](#) through [step 21](#) until all expansion cards are reinstalled or one of the expansion cards causes the tests to fail.

If the problem is not resolved, see "[Getting Help](#)."
-

Troubleshooting an Optical Drive

Problem

- 1 System cannot read data from a CD.
- 1 Optical drive indicator does not blink during boot.

Action

 **CAUTION:** See your *Product Information Guide* for complete information about safety precautions, working inside the computer, and protecting against electrostatic discharge.

1. Try using a different CD that you know works properly.
 2. Enter the System Setup program and ensure that the drive's IDE controller is enabled. See "Using the System Setup Program" in your *User's Guide*.
 3. Run the appropriate online diagnostic test. See "[Using Server Administrator Diagnostics](#)" in "Running System Diagnostics."
 4. Turn off the system and attached peripherals, and disconnect the system from the electrical outlet.
 5. Ensure that the optical drive interface cable is securely connected to the drive and the system board. To identify the connector on the system board, see [Figure A-3](#).
 6. Ensure that a power cable is securely connected to the drive.
 7. Reconnect the system to the electrical outlet, and turn on the system and attached peripherals.

If the problem is not resolved, see "[Getting Help](#)."
-

Troubleshooting a SCSI Tape Drive

Problem

- 1 Defective tape drive.
- 1 Defective tape cartridge.

- 1 Missing or corrupted tape-backup software or tape-drive device driver.
- 1 Defective SCSI controller card.

Action

 **CAUTION:** See your *Product Information Guide* for complete information about safety precautions, working inside the computer, and protecting against electrostatic discharge.

1. Run the System Setup program and ensure that the secondary SCSI channel is enabled and set to SCSI.
See "Using the System Setup Program" in your *User's Guide*.
 2. Remove the tape cartridge you were using when the problem occurred, and replace it with a tape cartridge that you know works.
 3. Ensure that the SCSI device drivers for the tape drive are installed and are configured correctly.
 4. Reinstall the tape-backup software as instructed in the tape-backup software documentation.
 5. Ensure that the tape drive's interface cable is connected to the tape drive and SCSI controller card.
 6. Verify that the tape drive is configured for a unique SCSI ID number and that the tape drive is terminated or not terminated, based on the interface cable used to connect the drive.
See the documentation for the tape drive for instructions on selecting the SCSI ID number and enabling or disabling termination.
 7. Run the appropriate online diagnostics tests. See "[Using Server Administrator Diagnostics](#)" in "Running System Diagnostics."
 8. Turn off the system and attached peripherals, and disconnect the system from the electrical outlet.
 9. Open the system. See "[Opening the System](#)."
 10. Check that the SCSI controller card is firmly seated in its connector. See "[Installing an Expansion Card](#)" in "Installing System Components."
 11. Close the system. See "[Closing the System](#)."
 12. Reconnect the system to the electrical outlet, and turn on the system, including attached peripherals.
 13. If the problem is not resolved, see the documentation for the tape drive for additional troubleshooting instructions.
 14. If you cannot resolve the problem, see "[Getting Help](#)" for information on obtaining technical assistance.
-

Troubleshooting SCSI Hard Drives

Troubleshooting a Hot-Plug or Front-Access (Non-Hot-Plug) SCSI Hard Drive

Problem

- 1 Device driver error.
- 1 Hard drive not recognized by the system.

Action

 **NOTICE:** This procedure can destroy data stored on the hard drive. Before you continue, back up all files on the hard drive.

1. Run the appropriate online diagnostic test. See "[Using Server Administrator Diagnostics](#)" in "Running System Diagnostics."
If the test fails, continue to the next step.
2. Run the SCSI controllers test and the hard-drive tests in the system diagnostics. See "[Running the System Diagnostics](#)."

For information about testing the controller, see the controller's documentation.

If the tests fail, continue to the next step.

3. If the SCSI hard drives are configured in a RAID array, restart the system and enter the RAID configuration utility.

 **NOTE:** To enter the utility, press <Ctrl><h>, <Ctrl><a>, or <Ctrl><m>, depending on the utility. See the documentation supplied with the controller for information about the configuration utility.

4. Ensure that the primary SCSI channel is enabled, and restart the system.
5. Verify that the device drivers are installed and configured correctly. See the operating system documentation.
6. Remove the bezel. See "[Removing the Bezel.](#)"
7. Remove the hard drive:
 - o If your hard drive is not configured in a RAID array, shut down the system, remove the hard drive and install it in another drive bay. See "[Front-Access SCSI Hard Drives \(Non-Hot-Plug\)](#)" in "Installing Drives."
 - o If your hard drive is configured in a RAID array with four hard drives, install a new hard drive. See "[Hot-Plug SCSI Hard Drives](#)" in "Installing Drives."
 - o If your hard drive is configured in a RAID array with up to three hard drives, remove the hard drive and install the drive in an empty drive bay. See "[Hot-Plug SCSI Hard Drives](#)" in "Installing Drives."

 **NOTICE:** Do not swap the hard drives in a four hard-drive RAID configuration. Doing so may corrupt the data on both hard drives.

8. Install the bezel. See "[Installing the Bezel.](#)"
9. If the system recognizes the hard drive, reinstall the hard drive in the original bay. See "[Hot-Plug SCSI Hard Drives](#)" or "[Front-Access SCSI Hard Drives \(Non-Hot-Plug\)](#)" in "Installing Drives."

If the hard drive functions properly in the original bay, the drive carrier could have intermittent problems. Replace the drive carrier. See "[Hot-Plug SCSI Hard Drives](#)" or "[Front-Access SCSI Hard Drives \(Non-Hot-Plug\)](#)" in "Installing Drives."

If the problem persists, the SCSI backplane board has a defective connector. See "[Getting Help.](#)"

 **CAUTION:** See your *Product Information Guide* for complete information about safety precautions, working inside the computer, and protecting against electrostatic discharge.

10. Check the SCSI cable connections inside the system:
 - a. Turn off the system, including any attached peripherals, and disconnect the system from the electrical outlet.
 - b. Open the system. See "[Opening the System.](#)"
 - c. Lay the system on its right side.
 - d. Remove the cover. See "[Removing the Cover.](#)"
 - e. Verify that the SCSI cable is securely connected to the controller card and the SCSI backplane.
 - f. Replace the cover. See "[Replacing the Cover.](#)"
 - g. Stand the system upright.
 - h. Install the bezel. See "[Installing the Bezel.](#)"

11. Format and partition the hard drive. See the operating system documentation.

12. If possible, restore the files to the drive.

If the problem persists, see "[Getting Help.](#)"

Troubleshooting a Cabled SCSI Hard Drive

Problem

- 1 Device driver error.
- 1 Hard drive not recognized by the system.

Action

 **NOTICE:** This procedure can destroy data stored on the hard drive. Before you continue, back up all files on the hard drive.

1. Run the appropriate online diagnostic test. See "[Using Server Administrator Diagnostics](#)" in "Running System Diagnostics."

If the test fails, continue to the next step.

2. Run the SCSI controllers test and the hard-drive tests in the system diagnostics. See "[Running the System Diagnostics](#)."

For information about testing the controller, see the SCSI or RAID controller card's documentation.

If the tests fail, continue to the next step.

3. Restart the system and enter the configuration utility.

 **NOTE:** To enter the utility, press <Ctrl><h>, <Ctrl><a>, or <Ctrl><m>, depending on the utility. See the documentation supplied with the controller for information about the configuration utility.

4. Ensure that the primary SCSI channel is enabled, and restart the system. See the controller card's documentation.

5. Ensure that the required device drivers are installed and configured correctly. See the *Dell OpenManage Server Assistant CD*.

 **CAUTION:** See your *Product Information Guide* for complete information about safety precautions, working inside the computer, and protecting against electrostatic discharge.

6. Turn off the system and attached peripherals, and disconnect the system from the electrical outlet.
7. Open the system. See "[Opening the System](#)."
8. Lay the system on its right side.
9. Ensure that the hard-drive interface cable is properly connected between the drive and the controller card. See the controller card's documentation.
10. If the hard drive is the boot drive, ensure that the drive is configured and connected properly. See "[Configuring the Boot Drive](#)" in "Installing Drives."
11. Ensure that a power cable is properly connected to the drive.
12. Ensure that the controller card is installed correctly.
13. Ensure that the hard drive is configured with a unique SCSI ID number and that the drive is terminated or not terminated as appropriate. See the documentation for the hard drive.
14. Install the cover. See "[Replacing the Cover](#)."
15. Stand the system upright.
16. Install the bezel. See "[Installing the Bezel](#)."
17. Reconnect the system to the electrical outlet, and turn on the system and attached peripherals.
18. Format and partition the hard drive. See the operating system documentation.
19. If possible, restore the files to the drive.
If the problem persists, see "[Getting Help](#)."

Troubleshooting SATA Hard Drives

Troubleshooting a SATA Hard Drive

Problem

- 1 Faulty hard drive.
- 1 Damaged or improperly connected hard-drive cables.

Action

 **CAUTION:** See your *Product Information Guide* for complete information about safety precautions, working inside the computer, and protecting against electrostatic discharge.

 **NOTICE:** This troubleshooting procedure can destroy data stored on the hard drive. Before you proceed, back up all files on the hard drive.

 **NOTE:** If the hard drive is used in a RAID configuration, see "[Troubleshooting a SATA Hard Drive in a RAID Configuration](#)."

1. Run the appropriate online diagnostic test. See "[Using Server Administrator Diagnostics](#)" in "Running the System Diagnostics."
2. Enter the System Setup program and verify that the system is configured correctly. See "Using the System Setup Program" in your *User's Guide*.
3. Remove the bezel. See "[Removing the Bezel](#)."
4. Turn off the system and attached peripherals, and disconnect the system from the electrical outlet.
5. Open the system. See "[Opening the System](#)."
6. Ensure that the hard-drive interface cable is properly connected between the drive and the system board.
To identify system board connectors, see [Figure A-3](#).
7. If the hard drive is the boot drive, ensure that the drive is configured and connected properly. See "[Configuring the Boot Drive](#)" in "Installing Drives."
8. Ensure that the power cable is properly connected to the drive.
9. Install the cover. See "[Replacing the Cover](#)."
10. Reconnect the system to the electrical outlet, and turn on the system and attached peripherals.
11. Format and partition the hard drive. See the operating system documentation.
12. If possible, restore the files to the drive.
If the problem persists, see "[Getting Help](#)."

Troubleshooting a SATA Hard Drive in a RAID Configuration

Problem

- 1 Device driver error.
- 1 Damaged or improperly connected hard-drive cables.

Action

 **CAUTION:** See your *Product Information Guide* for complete information about safety precautions, working inside the computer, and protecting against electrostatic discharge.

 **NOTICE:** This troubleshooting procedure can destroy data stored on the hard drive. Before you proceed, back up all files on the hard drive.

1. Run the appropriate online diagnostic test. See "[Using Server Administrator Diagnostics](#)" in "Running the System Diagnostics."
2. Restart your system and enter the RAID configuration utility. See the RAID controller documentation.
3. Ensure that the required device drivers are installed and are configured correctly. See the *Dell OpenManage Server Assistant* CD and the RAID controller's documentation.
4. Turn off the system and attached peripherals, and disconnect the system from the electrical outlet.

5. Open the system. See "[Opening the System.](#)"
 6. Ensure that the hard-drive interface cable is properly connected to the drive and to the controller card. See the documentation that accompanied the controller card.
 7. If the hard drive is the boot drive, ensure that the drive is configured and connected properly. See "[Configuring the Boot Drive](#)" in "Installing Drives."
 8. Ensure that the power cable is properly connected to the drive.
 9. Close the system. See "[Closing the System.](#)"
 10. Reconnect the system to the electrical outlet, and turn on the system and attached peripherals.
If the problem persists, continue to the next step.
 11. Format and partition the hard drive. See the operating system documentation.
 12. If possible, restore the files to the drive.
If the problem persists, see "[Getting Help.](#)"
-

Troubleshooting a RAID Controller Card

 **NOTE:** When troubleshooting a RAID controller card, also see the documentation for your operating system and the RAID controller.

Problem

- 1 Error message indicates a RAID controller problem.
- 1 RAID controller performs incorrectly or not at all.

Action

 **CAUTION:** See your *Product Information Guide* for complete information about safety precautions, working inside the computer, and protecting against electrostatic discharge.

1. Run the appropriate online diagnostic test. See "[Using Server Administrator Diagnostics](#)" in "Running the System Diagnostics."
 2. Turn off the system and attached peripherals, and disconnect the system from the electrical outlet.
 3. Open the system. See "[Opening the System.](#)"
 4. Ensure that the controller card is firmly seated in its connector. See "[Installing an Expansion Card](#)" in "Installing System Components."
 5. Ensure that the appropriate cables are firmly connected to their corresponding connectors on the controller card and SCSI backplane.
 6. Close the system. See "[Closing the System.](#)"
 7. Reconnect the system to the electrical outlet, and turn on the system and attached peripherals.
If the problem persists, see the RAID controller's documentation for more information on troubleshooting.
-

Troubleshooting Expansion Cards

 **NOTE:** When troubleshooting an expansion card, see the documentation for your operating system and the expansion card.

Problem

- 1 Error message indicates a problem with an expansion card.
- 1 Expansion card performs incorrectly or not at all.

Action

 **CAUTION:** See your *Product Information Guide* for complete information about safety precautions, working inside the computer, and protecting against electrostatic discharge.

1. Run the appropriate online diagnostic test. See "[Using Server Administrator Diagnostics](#)" in "Running System Diagnostics."
2. Turn off the system and attached peripherals, and disconnect the system from the electrical outlet.
3. Open the system. See "[Opening the System](#)."
4. Ensure that each expansion card is firmly seated in its connector. See "[Installing an Expansion Card](#)" in "Installing System Components."
5. Close the system. See "[Closing the System](#)."
6. Reconnect the system to the electrical outlet, and turn on the system and attached peripherals.
If the problem persists, go to the next step.
7. Turn off the system and attached peripherals, and disconnect the system from the electrical outlet.
8. Open the system. See "[Opening the System](#)."
9. Remove all expansion cards installed in the system. See "[Removing an Expansion Card](#)" in "Installing System Components."
10. Close the system. See "[Closing the System](#)."
11. Reconnect the system to the electrical outlet, and turn on the system and attached peripherals.
12. Run the appropriate online diagnostic test.
If the tests fail, see "[Getting Help](#)."
13. For each expansion card you removed in [step 9](#), perform the following steps:
 - a. Turn off the system and attached peripherals, and disconnect the system from the electrical outlet.
 - b. Open the system. See "[Opening the System](#)."
 - c. Reinstall one of the expansion cards. See "[Installing an Expansion Card](#)."
 - d. Close the system. See "[Closing the System](#)."
 - e. Run the appropriate diagnostic test.
If the tests fail, see "[Getting Help](#)."

Troubleshooting the Microprocessor

Problem

1. Error message indicates a processor problem.

Action

 **CAUTION:** See your *Product Information Guide* for complete information about safety precautions, working inside the computer, and protecting against electrostatic discharge.

1. Run the appropriate online diagnostics test. See "[Using Server Administrator Diagnostics](#)" in "Running the System Diagnostics."
2. Turn off the system and attached peripherals, and disconnect the system from the electrical outlet.
3. Open the system. See "[Opening the System](#)."
4. Ensure that the processor and heat sink are properly installed. See "[Processor](#)" in "Installing System Components."

5. Close the system. See "[Closing the System.](#)"
6. Reconnect the system to the electrical outlet, and turn on the system and attached peripherals.
7. Run the appropriate online diagnostic test.
If the tests fail or the problem persists, continue to the next step.
8. Turn off the system and attached peripherals, and disconnect the system from the electrical outlet.
9. Open the system. See "[Opening the System.](#)"
10. Replace the processor with another processor of the same capacity. See "[Processor](#)" in "Installing System Components."
11. Close the system. See "[Closing the System.](#)"
12. Run the appropriate online diagnostic test.
If the tests complete successfully, replace the processor. See "[Getting Help.](#)"
If the problem persists, see "[Getting Help.](#)"

[Back to Contents Page](#)

Installing System Components

Dell™ PowerEdge™ 800 Systems Installation and Troubleshooting Guide

- [Cooling Shroud](#)
- [System Fans](#)
- [Power Supply](#)
- [Expansion Cards](#)
- [System Memory](#)
- [Processor](#)
- [Installing a RAC Card](#)
- [System Battery](#)

This section describes how to install the following system components:

- 1 Cooling shroud
 - 1 System fans
 - 1 Power supply
 - 1 Memory modules
 - 1 Processor
 - 1 Expansion cards
 - 1 System battery
-

Cooling Shroud

Removing the Cooling Shroud

 **CAUTION:** See your *Product Information Guide* for complete information about safety precautions, working inside the computer, and protecting against electrostatic discharge.

1. Turn off the system, including any attached peripherals, and disconnect the system from the electrical outlet.
2. Remove the bezel. See "[Removing the Bezel](#)" in "Troubleshooting Your System."
3. Lay the system on its right side.
4. Remove the cover. See "[Removing the Cover](#)" in "Troubleshooting Your System."
5. Disconnect the power cables and hard-drive interface cable connectors from the SCSI backplane (if applicable) or hard drives.
6. Press the shroud release tab on the back panel toward the power supply. See [Figure 6-1](#).
7. Lift the cooling shroud out of the system. See [Figure 6-1](#).

Figure 6-1. Removing the Cooling Shroud

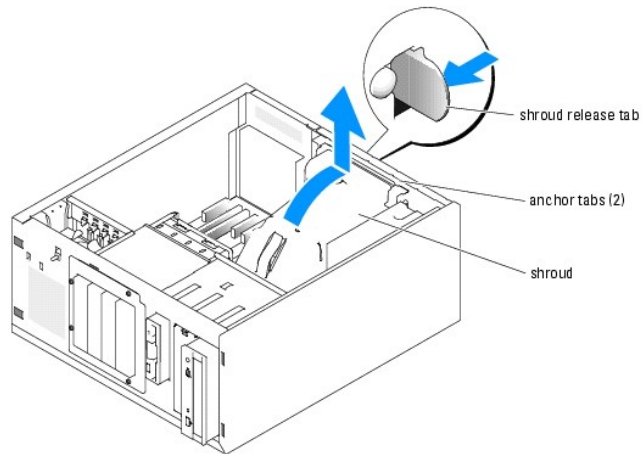

Installing the Cooling Shroud

1. Ensure that no tools or loose parts are left inside the system.
 2. Align the anchor tabs on the cooling shroud with the notches in the system chassis.
 3. Reposition the SCSI cable and power cables so they do not obstruct the memory modules and interfere with installing the cooling shroud.
 4. Gently lower the cooling shroud until the shroud release tab on the back panel snaps into place.
 5. Reconnect the power cable(s) to the SCSI backplane (if applicable) or the hard drive(s).
-

System Fans

The system includes the following cooling fans:

- 1 Front system fan
- 1 Back system fan

Removing the Front System Fan

⚠ CAUTION: See your *Product Information Guide* for complete information about safety precautions, working inside the computer, and protecting against electrostatic discharge.

[Figure 6-2](#) illustrates the front system fan inside the system and the fan cable routing hole in the expansion-card guide bracket.

1. Turn off the system, including any attached peripherals, and disconnect the system from the electrical outlet.
2. Remove the bezel. See "[Removing the Bezel](#)" in "Troubleshooting Your System."
3. Lay the system on its right side.
4. Remove the cover. See "[Removing the Cover](#)" in "Troubleshooting Your System."
5. Disconnect the fan power cable from the FRONT_FAN connector on the system board. See [Figure 6-2](#).

Figure 6-2. Front System Fan Power Cable

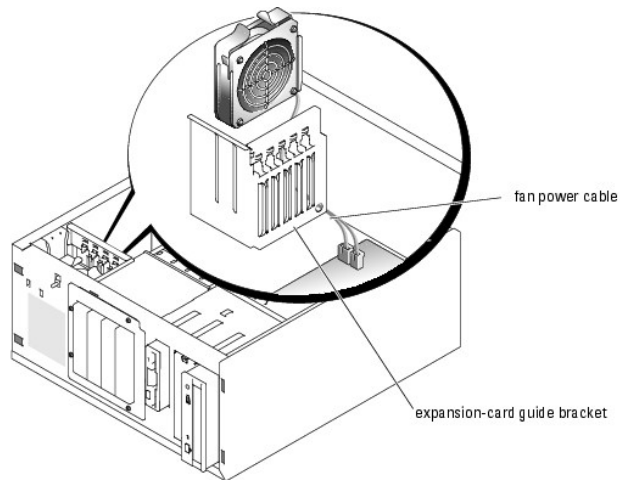

6. Compress the two release tabs on the top of the fan assembly and lift the fan assembly away from the system. See [Figure 6-3](#).

Figure 6-3. Removing and Replacing the Front System Fan

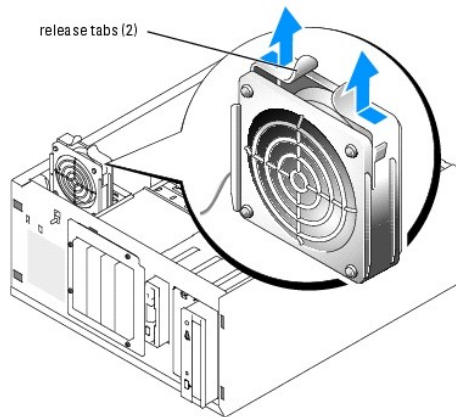

Installing the Front System Fan

⚠ CAUTION: See your *Product Information Guide* for complete information about safety precautions, working inside the computer, and protecting against electrostatic discharge.

1. Insert the fan power cable through the routing hole in the expansion-card guide bracket. See [Figure 6-2](#).
2. Align the fan assembly with the slots in the chassis and lower the assembly into the chassis. See [Figure 6-3](#).
3. Pull the fan cable through the routing hole in the expansion-card guide bracket. See [Figure 6-2](#).
4. Connect the fan cable connector to the FRONT_FAN connector on the system board.
5. Install the cover. See "[Replacing the Cover](#)" in "Troubleshooting Your System."
6. Stand the system upright.
7. Install the bezel. See "[Installing the Bezel](#)" in "Troubleshooting Your System."
8. Reconnect the system to its electrical outlet and turn the system on, including any attached peripherals.

Removing the Back System Fan

⚠ CAUTION: See your *Product Information Guide* for complete information about safety precautions, working inside the computer, and protecting against electrostatic discharge.

1. Turn off the system, including any attached peripherals, and disconnect the system from the electrical outlet.
2. Remove the bezel. See "[Removing the Bezel](#)" in "Troubleshooting Your System."
3. Lay the system on its right side.
4. Remove the cover. See "[Removing the Cover](#)" in "Troubleshooting Your System."
5. Remove the cooling shroud. See "[Removing the Cooling Shroud](#)."
6. Disconnect the fan cable from the BACK_FAN connector on the system board. To identify system board connectors, see [Figure A-3](#).
7. Pull the release tab on the fan assembly away from the back panel and slide the fan assembly about 0.63 cm (0.25 inch) toward the expansion-card slots. See [Figure 6-4](#).
8. Pull the fan assembly forward and lift the assembly out of the system. See [Figure 6-4](#).

Figure 6-4. Removing the Back System Fan

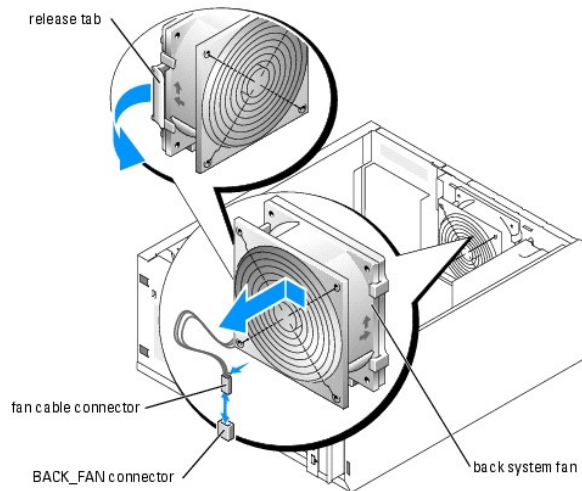

Installing the Back System Fan

⚠ CAUTION: See your *Product Information Guide* for complete information about safety precautions, working inside the computer, and protecting against electrostatic discharge.

1. Align the tabs on the fan bracket with the mounting holes in the back panel and slide the fan assembly toward the power supply about 0.6 cm (0.25 inch) until the fan bracket release tab snaps into place. See [Figure 6-4](#).
 2. Connect the fan cable to the BACK_FAN connector on the system board.
To identify system board connectors, see [Figure A-3](#).
 3. Install the cooling shroud. See "[Installing the Cooling Shroud](#)."
 4. Install the cover. See "[Replacing the Cover](#)" in "Troubleshooting Your System."
 5. Stand the system upright.
 6. Install the bezel. See "[Installing the Bezel](#)" in "Troubleshooting Your System."
 7. Reconnect the system to its electrical outlet and turn the system on, including any attached peripherals.
-

Power Supply

Removing the Power Supply

⚠ CAUTION: See the *Product Information Guide* for complete information about safety precautions, working inside the computer, and protecting against electrostatic discharge.

1. Turn off the system and attached peripherals, and disconnect the system from the electrical outlet.
2. Remove the bezel. See "[Removing the Bezel](#)" in "Troubleshooting Your System."
3. Lay the system on its right side.
4. Remove the cover. See "[Removing the Cover](#)" in "Troubleshooting Your System."
5. Disconnect the DC power cables from the following components:
 - 1 POWER CONN connector on the backplane board (if applicable)
 - 1 PWR CONN and 12V connectors on the system board
 - 1 Hard drives or SCSI backplane board
 - 1 Diskette drive (if applicable)
 - 1 Optical drive (if applicable)
 - 1 Tape backup drive (if applicable)
6. Remove the cooling shroud. See "[Removing the Cooling Shroud](#)."
7. Remove the four screws securing the power supply to the back panel. See [Figure 6-5](#).

Figure 6-5. Removing the Power Supply

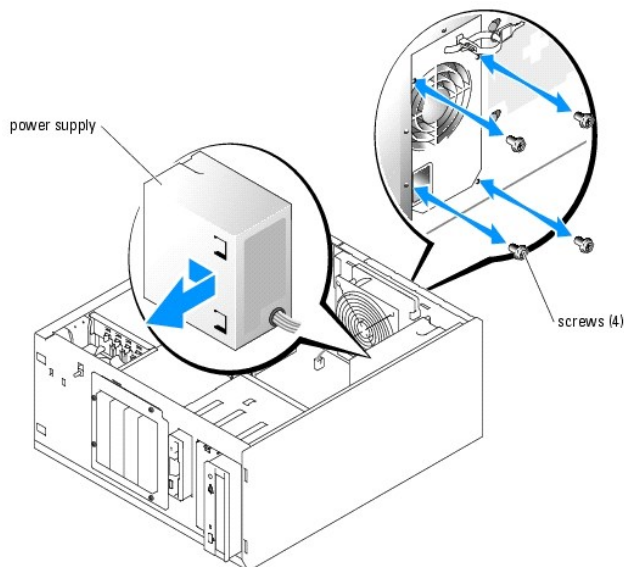

8. Slide the power supply toward the front of the system, and then lift the power supply up and out of the system.

Replacing the Power Supply

1. Lower the power supply into the system and align the mounting holes with the holes on the back panel.
2. Install the four screws securing the power supply to the back panel.

3. Install the cooling shroud. See "[Installing the Cooling Shroud](#)."
 4. Connect the DC power cables to the following components:
 - 1 POWER CONN connector on the backplane board (if applicable)
 - 1 PWR CONN and 12V connectors on the system board
 - 1 Hard drives or SCSI backplane.
 - 1 Diskette drive (if applicable)
 - 1 Optical drive (if applicable)
 - 1 Tape backup drive (if applicable)
 5. Install the cover. See "[Replacing the Cover](#)" in "Troubleshooting Your System."
 6. Stand the system upright.
 7. Install the bezel. See "[Installing the Bezel](#)" in "Troubleshooting Your System."
 8. Reconnect the system to its electrical outlet and turn the system on, including any attached peripherals.
-

Expansion Cards

Your system supports up to five full-length expansion cards, installed in connectors on a riser card. The expansion slots are configured as follows:

- o Slots 1 and 2 are x1 lane-width PCI-Express expansion slots.
- o Slots 3 and 4 are 3.3-V, 64-bit, 100-MHz PCI-X expansion slots. 133-MHz cards installed in these slots will run at 100 MHz.
- o Slot 5 is a 5-V, 32-bit, 33-MHz legacy PCI expansion slot.

[Figure 6-6](#) shows the relative locations of the expansion-card slots.

➡ **NOTICE:** If you install a RAC card, it must be installed in PCI slot SLOT_5.

Figure 6-6. Expansion Slots

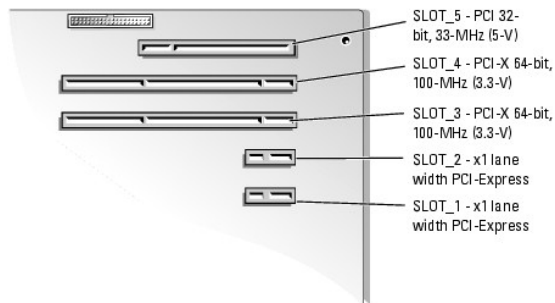

Installing an Expansion Card

⚠ CAUTION: See your *Product Information Guide* for complete information about safety precautions, working inside the computer, and protecting against electrostatic discharge.

1. Unpack the expansion card, and prepare it for installation.

For instructions, see the documentation that accompanied the card.
2. Turn off the system, including any attached peripherals, and disconnect the system from the electrical outlet.
3. Remove the bezel. See "[Removing the Bezel](#)" in "Troubleshooting Your System."
4. Lay the system on its right side.

5. Remove the cover. See ["Removing the Cover"](#) in "Troubleshooting Your System."
6. Remove the filler bracket from the expansion slot.
7. Install the expansion card. See [Figure 6-7](#).
 - a. Position the expansion card so that the card-edge connector aligns with the expansion- card connector on the system board.
 - b. Insert the card-edge connector firmly into the expansion-card connector until the card is fully seated.
 - c. Install the screw that secures the expansion-card bracket to the back panel.
8. Connect any cables that should be attached to the card.
See the documentation that accompanied the card for information about its cable connections.
9. Install the cover. See ["Replacing the Cover"](#) in "Troubleshooting Your System."
10. Stand the system upright.
11. Install the bezel. See ["Installing the Bezel"](#) in "Troubleshooting Your System."
12. Reconnect the system to its electrical outlet and turn the system on, including any attached peripherals.
13. Install any device drivers required for the card as described in the documentation for the card.

Figure 6-7. Removing and Installing an Expansion Card

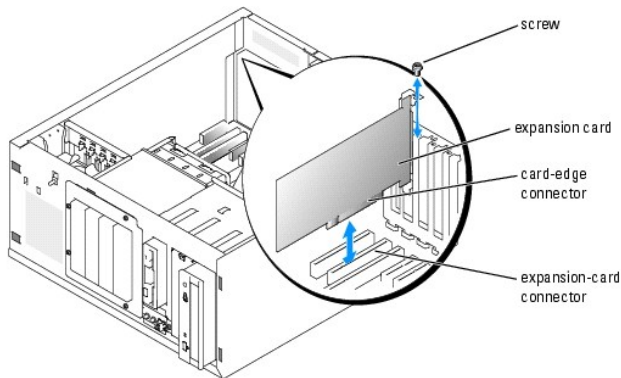

Removing an Expansion Card

⚠ CAUTION: See your *Product Information Guide* for complete information about safety precautions, working inside the computer, and protecting against electrostatic discharge.

1. Turn off the system, including any attached peripherals, and disconnect the system from the electrical outlet.
2. Remove the bezel. See ["Removing the Bezel"](#) in "Troubleshooting Your System."
3. Lay the system on its right side.
4. Remove the cover. See ["Removing the Cover"](#) in "Troubleshooting Your System."
5. Disconnect any cables attached to the card.
6. Remove the expansion card (see [Figure 6-7](#)):
 - a. Remove the screw that secures the expansion-card bracket to the back panel.
 - b. Grasp the expansion card by its top corners, and carefully remove it from the expansion- card connector.

➡ NOTICE: You must install a filler bracket over an empty expansion slot to maintain Federal Communications Commission (FCC) certification of the system. The brackets also help keep dust and dirt out of the system and aid in proper cooling and airflow inside the system.

7. If you are removing the card permanently, install a metal filler bracket over the empty expansion slot opening and close the expansion-card latch.
8. Install the cover. See "[Replacing the Cover](#)" in "Troubleshooting Your System."
9. Stand the system upright.
10. Install the bezel. See "[Installing the Bezel](#)" in "Troubleshooting Your System."
11. Reconnect the system to its electrical outlet and turn the system on, including any attached peripherals.

System Memory

You can upgrade your system memory to a maximum of 4 GB by installing combinations of 256-MB, 512-MB, or 1-GB 2-way unbuffered ECC DDR 2 400/533 memory modules. The system memory is located on the system board adjacent to the power supply bays. See [Figure A-3](#). The memory module sockets are arranged in two banks on two channels (A and B). The memory module banks are identified as follows:

- 1 Bank 1: DIMM1_A and DIMM1_B
- 1 Bank 2: DIMM2_A and DIMM2_B

General Memory Module Installation Guidelines

- 1 If only one memory module is installed, it must be installed in socket DIMM1_A.
- 1 If two or more memory modules are installed, they must be installed in pairs of matched memory size, speed, and technology.

[Table 6-1](#) shows examples of different memory configurations.

Table 6-1. Sample Memory Configurations

Total Memory	DIMM1_A	DIMM2_A	DIMM1_B	DIMM2_B	Memory Mode
256 MB	256 MB	none	none	none	Single channel
512 MB	256 MB	none	256 MB	none	Dual channel, interleaved
512 MB	512 MB	none	none	none	Single channel
1 GB	256 MB	256 MB	256 MB	256 MB	Dual channel, interleaved
1 GB	512 MB	none	512 MB	none	Dual channel, interleaved
1 GB	1 GB	none	none	none	Single channel
1.5 GB	512 MB	256 MB	512 MB	256 MB	Dual channel, interleaved
2 GB	512 MB	512 MB	512 MB	512 MB	Dual channel, interleaved
2 GB	1 GB	none	1 GB	none	Dual channel, interleaved
3 GB	1 GB	512 MB	1 GB	512 MB	Dual channel, interleaved
4 GB	1 GB	1 GB	1 GB	1 GB	Dual channel, interleaved

Installing Memory Modules

⚠ CAUTION: See your *Product Information Guide* for complete information about safety precautions, working inside the computer, and protecting against electrostatic discharge.

1. Turn off the system, including any attached peripherals, and disconnect the system from the electrical outlet.
2. Remove the bezel. See "[Removing the Bezel](#)" in "Troubleshooting Your System."
3. Lay the system on its right side.
4. Remove the cover. See "[Removing the Cover](#)" in "Troubleshooting Your System."
5. Remove the cooling shroud. See "[Removing the Cooling Shroud](#)."
6. Locate the memory module sockets. See [Figure A-3](#).
7. Press the ejectors on the memory module socket down and out, as shown in [Figure 6-8](#), to allow the memory module to be inserted into the socket.

Figure 6-8. Installing and Removing a Memory Module

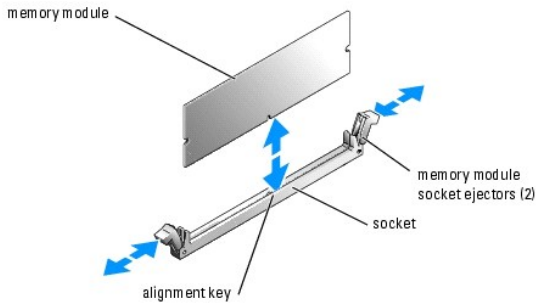

8. Align the memory module's edge connector with the alignment key on the memory module socket, and insert the memory module in the socket.

NOTE: The memory module socket has an alignment key that allows you to install the memory module in the socket in only one way.

9. Press down on the memory module with your thumbs while pulling up on the ejectors with your index fingers to lock the memory module into the socket.

When the memory module is properly seated in the socket, the ejectors on the memory module socket align with the ejectors on the other sockets that have memory modules installed.

10. Repeat [step 6](#) through [step 9](#) of this procedure to install the remaining memory modules. See [Table 6-1](#) for sample memory configurations.
11. Install the cooling shroud. See "[Installing the Cooling Shroud](#)."
12. Install the cover. See "[Replacing the Cover](#)" in "Troubleshooting Your System."
13. Stand the system upright.
14. Install the bezel. See "[Installing the Bezel](#)" in "Troubleshooting Your System."
15. Reconnect the system to its electrical outlet and turn the system on, including any attached peripherals.
16. (Optional) Press <F2> to enter the System Setup program, and check the **System Memory** setting on the main **System Setup** screen.
The system should have already changed the value to reflect the newly installed memory.
17. If the value is incorrect, one or more of the memory modules may not be installed properly. Repeat [step 1](#) through [step 16](#) of this procedure, checking to ensure that the memory modules are firmly seated in their sockets.
18. Run the system memory test in the system diagnostics. See "[Running the System Diagnostics](#)."

Removing Memory Modules

CAUTION: See your *Product Information Guide* for complete information about safety precautions, working inside the computer, and protecting against electrostatic discharge.

1. Turn off the system, including any attached peripherals, and disconnect the system from the electrical outlet.
2. Remove the bezel. See "[Removing the Bezel](#)" in "Troubleshooting Your System."
3. Lay the system on its right side.
4. Remove the cover. See "[Removing the Cover](#)" in "Troubleshooting Your System."
5. Remove the cooling shroud. See "[Removing the Cooling Shroud](#)."
6. Locate the memory module sockets. See [Figure A-3](#).
7. Press down and out on the ejectors on each end of the socket until the memory module pops out of the socket. See [Figure 6-8](#).
8. Install the cooling shroud. See "[Installing the Cooling Shroud](#)."

9. Install the cover. See "[Replacing the Cover](#)" in "Troubleshooting Your System."
 10. Stand the system upright.
 11. Install the bezel. See "[Installing the Bezel](#)" in "Troubleshooting Your System."
-

Processor

You can upgrade the system processor to take advantage of future options in speed and functionality.

The following items are included in the processor upgrade kit:

- 1 Processor
- 1 Heat sink

Removing the Processor

 **CAUTION:** See your *Product Information Guide* for complete information about safety precautions, working inside the computer, and protecting against electrostatic discharge.

1. Turn off the system, including any attached peripherals, and disconnect the system from the electrical outlet.
2. Remove the bezel. See "[Removing the Bezel](#)" in "Troubleshooting Your System."
3. Lay the system on its right side.
4. Remove the cover. See "[Removing the Cover](#)" in "Troubleshooting Your System."
5. Remove the cooling shroud. See "[Removing the Cooling Shroud](#)."

 **NOTICE:** Never remove the heat sink from a processor unless you intend to remove the processor. The heat sink is necessary to maintain proper thermal conditions.

6. Remove the heat sink. See [Figure 6-9](#).
 - a. Open one securing clip by pressing the end of the clip down and away from the retention until it clears the securing tab on the retention module, and then lift the clip up.
 - b. Repeat step a for the remaining securing clip.
 - c. Rotate the heat sink slightly and then lift the heat sink off the processor. Do not pry the processor off the heat sink.

Figure 6-9. Removing the Heat Sink

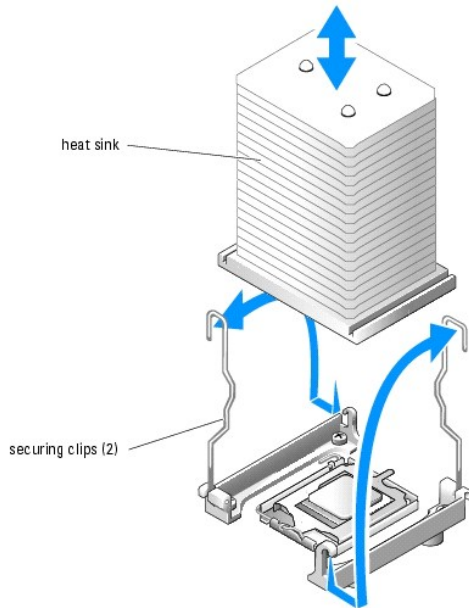

7. Press down on the processor socket release lever, then pull the release lever upward to the fully open position. See [Figure 6-10](#).
8. Open the processor cover. See [Figure 6-10](#).
9. Lift the processor vertically out of the socket. Leave the processor cover and release lever in the open position so that the socket is ready for the new processor. See [Figure 6-10](#).

Figure 6-10. Replacing the Processor

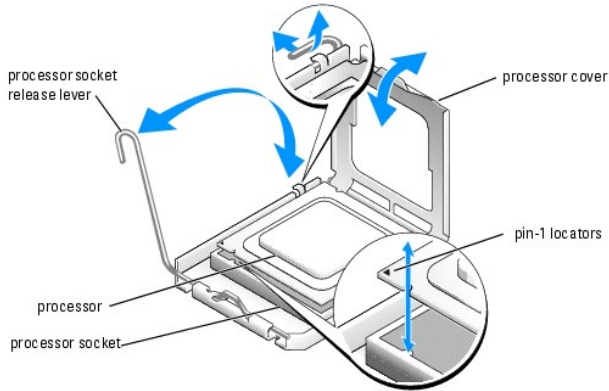

Installing a Processor

⚠ CAUTION: See your *Product Information Guide* for complete information about safety precautions, working inside the computer, and protecting against electrostatic discharge.

1. Unpack the new processor and heat sink.
2. Ensure that the processor socket release lever is in the fully open position.
3. Align the pin 1 corners of the processor and socket. See [Figure 6-10](#).

🕒 NOTICE: You must position the processor correctly in the socket to avoid damaging the processor and the system board when you turn on the system. Be careful not to touch or bend the pins on the socket.

4. Set the processor lightly in the socket and ensure that the processor is level in the socket. When the processor is positioned correctly, press it gently to seat it in the socket.
5. Close the processor cover.
6. Rotate the release lever back down until it snaps into place, securing the processor cover.

 **NOTICE:** Do not operate the system without the heat sink installed. The heat sink is required to maintain proper thermal conditions.

7. Remove the thermal grease protective cover from the new heat sink.

If you did not receive a new heat sink with the processor, see "[Getting Help](#)."

8. Lower the heat sink onto the processor. See [Figure 6-9](#).
9. Secure the heat sink to the retention module.
 - a. Gently press down on the heat sink and then press one securing clip to secure it.
 - b. Repeat [step a](#) for the remaining securing clip.
10. Ensure that the back fan connector is connected to the BACK_FAN connector on the system board. See [Figure A-3](#).
11. Install the cooling shroud. See "[Installing the Cooling Shroud](#)."
12. Install the cover. See "[Replacing the Cover](#)" in "Troubleshooting Your System."
13. Stand the system upright.
14. Install the bezel. See "[Installing the Bezel](#)" in "Troubleshooting Your System."
15. Reconnect the system to its electrical outlet and turn the system on, including any attached peripherals.
16. Enter the System Setup program, and ensure that the processor options match the new system configuration. See "Using the System Setup Program" in your *User's Guide*.

As the system boots, it detects the presence of the new processor and automatically changes the system configuration information in the System Setup program. A message similar to the following appears:

```
One 2.3 GHz Processor, Processor Bus: 533 MHz, L2 cache 256 KB Advanced
```
17. Confirm that the top line of the system data area in the System Setup program correctly identifies the installed processor. See "Using the System Setup Program" in your *User's Guide*.
18. Exit the System Setup program.
19. Ensure that your system is running the latest BIOS version.

You can download the latest BIOS version from the Dell Support website located at support.dell.com
20. Run the system diagnostics to verify that the new processor is operating correctly.

See "[Running the System Diagnostics](#)" for information on running the diagnostics and troubleshooting any problems that may occur.

Installing a RAC Card

 **CAUTION:** See your *Product Information Guide* for complete information about safety precautions, working inside the computer, and protecting against electrostatic discharge.

1. Turn off the system, including any attached peripherals, and disconnect the system from the electrical outlet.
2. Remove the bezel. See "[Removing the Bezel](#)" in "Troubleshooting Your System."
3. Lay the system on its right side.
4. Remove the cover. See "[Removing the Cover](#)" in "Troubleshooting Your System."
5. Install the RAC card in PCI expansion slot SLOT_5.

See "[Installing an Expansion Card](#)" for information on installing the card.

6. Connect the cable from the RAC card to connector RAC_CONN on the system board. See [Figure A-3](#).
7. Install the cover. See "[Replacing the Cover](#)" in "Troubleshooting Your System."
8. Stand the system upright.
9. Install the bezel. See "[Installing the Bezel](#)" in "Troubleshooting Your System."
10. Reconnect the system to its electrical outlet and turn the system on, including any attached peripherals.
11. Enter the System Setup program and verify that the setting for the RAC card has changed to reflect the presence of the card. See "Using the System Setup Program" in your *User's Guide*.

See the RAC card documentation for information on configuring and using the RAC card.

System Battery

Replacing the System Battery

⚠ CAUTION: See your *Product Information Guide* for complete information about safety precautions, working inside the computer, and protecting against electrostatic discharge.

1. Enter the System Setup program and record the option settings on the System Setup screens.
See "Using the System Setup Program" in the *User's Guide*.
2. Turn off the system, including any attached peripherals, and disconnect the system from the electrical outlet.
3. Remove the bezel. See "[Removing the Bezel](#)" in "Troubleshooting Your System."
4. Lay the system on its right side.
5. Remove the cover. See "[Removing the Cover](#)" in "Troubleshooting Your System."
6. Remove the system battery. See [Figure A-3](#) for the battery socket location on the system board.
 - a. Pull the latch away from the battery. See [Figure 6-11](#).
 - b. Lift the battery out of the battery socket.

Figure 6-11. Removing the System Battery

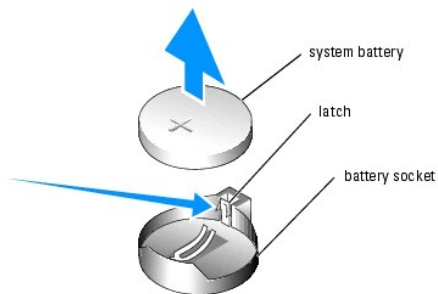

➡ NOTICE: You must install the new system battery with the side labeled "+" facing up. See [Figure 6-11](#).

7. To install the new system battery, hold the battery with the side labeled "+" facing up, and then press the battery straight down into the battery socket until the latch snaps into place over the edge of the battery. See [Figure 6-11](#).
8. Install the cover. See "[Replacing the Cover](#)" in "Troubleshooting Your System."
9. Stand the system upright.

10. Install the bezel. See "[Installing the Bezel](#)" in "Troubleshooting Your System."
 11. Reconnect the system to its electrical outlet and turn the system on, including any attached peripherals.
 12. Enter the System Setup program to confirm that the battery operates properly.
 13. From the main screen, select **System Time** to enter the correct time and date.
 14. Re-enter any system configuration information that is no longer displayed on the System Setup screens, and then exit the System Setup program.
 15. To test the newly installed battery, see "[Troubleshooting the System Battery](#)" in "Troubleshooting Your System."
-

[Back to Contents Page](#)

Installing Drives

Dell™ PowerEdge™ 800 Systems Installation and Troubleshooting Guide

- [Connecting Drives](#)
- [Front-Panel Drive Inserts](#)
- [Diskette Drive](#)
- [5.25-Inch Drives](#)
- [Hard Drives](#)
- [Cabled SATA and SCSI Hard Drives](#)
- [Front-Access SCSI Hard Drives \(Non-Hot-Plug\)](#)
- [Hot-Plug SCSI Hard Drives](#)
- [Installing the Optional SCSI Backplane Board](#)
- [Installing a RAID Controller Card](#)

Your system supports the following drives:

- 1 Up to two externally accessible 5.25-inch drives (typically optical and tape backup drives). An optical drive is standard in the first external drive bay, and a tape backup device can be installed in the second external drive bay.
- 1 An externally accessible 3.5-inch diskette drive.
- 1 Up to four 1-inch SATA or SCSI hard drives. Four hard drive configurations are available:
 - o Cabled SATA drives. See "[Cabled SATA and SCSI Hard Drives](#)."
 - o Cabled SCSI drives (requires optional SCSI controller card). See "[Cabled SATA and SCSI Hard Drives](#)."
 - o Front-access (non-hot-plug) SCSI drives (requires optional SCSI backplane and optional SCSI controller card). See "[Front-Access SCSI Hard Drives \(Non-Hot-Plug\)](#)" and "[Installing the Optional SCSI Backplane Board](#)."
 - o Hot-plug SCSI drives (requires optional SCSI backplane and optional SCSI RAID controller). See "[Hot-Plug SCSI Hard Drives](#)," "[Installing a RAID Controller Card](#)," and "[Installing the Optional SCSI Backplane Board](#)."-->

Connecting Drives

Interface Cables

Most interface connectors are keyed for correct insertion. Keying ensures that the pin-1 wire in the cable connects to pin 1 in the connectors on both ends. When you disconnect an interface cable, take care to grasp the cable connector, rather than the cable itself, to avoid stress on the cable.

Drive Cable Configurations

Your system can accommodate many different drive configurations, each with specific cable requirements. [Table 7-1](#) shows the cable requirements for common drive configurations.



 **NOTE:** Installing SATA and SCSI hard drives in the same system is not supported.

Table 7-1. Drive Cable Configuration

Drives	Required Cable	Cable Connections
IDE optical drives, and IDE and SCSI tape drives (See Figure 7-4 .)	40-pin IDE 2-drop cable or SCSI 1-drop cable (terminated)	IDE drive and primary IDE connector on system board or the SCSI tape device and the SCSI controller card
Up to four cabled SATA hard drives (See Figure 7-7 .)	7-pin SATA hard-drive cable (one cable per drive)	SATA hard drives and SATA port connectors on the system board, or on a RAID controller card.
Up to four cabled (non-hot-plug) SCSI hard-drives (See Figure 7-9 .)	94-cm (37-inch) SCSI 4-drop cable (terminated)	SCSI hard drives and SCSI RAID controller or SCSI controller card
Up to four front-access or hot-plug SCSI hard drives connected to the SCSI backplane (See Figure 7-12 .)	38-cm (15-inch) 68-pin SCSI 1-drop cable (unterminated)	SCSI backplane and the SCSI controller card

DC Power Cables

Each drive must connect to a DC power cable from the system power supply. These power cables are used for the 3.5-inch diskette drive, 5.25-inch devices, and hard drives.

 **NOTICE:** To avoid electrical damage to internal system components, install a cover connector on any unused connectors on hard-drive power cables.

Front-Panel Drive Inserts

To help keep dust and dirt out of the system, a plastic insert in the bezel covers each empty external drive bay. Additionally, each empty external drive bay is covered by a metal insert in the chassis to maintain Federal Communications Commission (FCC) certification of the system.

Before you install a 5.25-inch drive in an empty external drive bay, you must first remove both front-panel drive inserts. If you remove a 5.25-inch drive permanently, you must install both inserts.

Removing the Front-Panel Drive Inserts

⚠ CAUTION: See your *Product Information Guide* for complete information about safety precautions, working inside the computer, and protecting against electrostatic discharge.

1. Turn off the system, including any attached peripherals, and disconnect the system from the electrical outlet.
2. Remove the bezel. See "[Removing the Bezel](#)" in "Troubleshooting Your System."
3. Remove the bezel drive insert (see [Figure 7-1](#)):
 - a. From inside the bezel, press the center of the insert outward with your thumbs to loosen the tabs on the sides of the insert.
 - b. Pull the insert out of the bezel.
4. Remove the chassis drive insert (see [Figure 7-1](#)):
 - a. Press both sides of the insert to loosen the tabs on the insert.
 - b. Pull the insert out of the chassis.

Figure 7-1. Removing the Front-Panel Drive Inserts

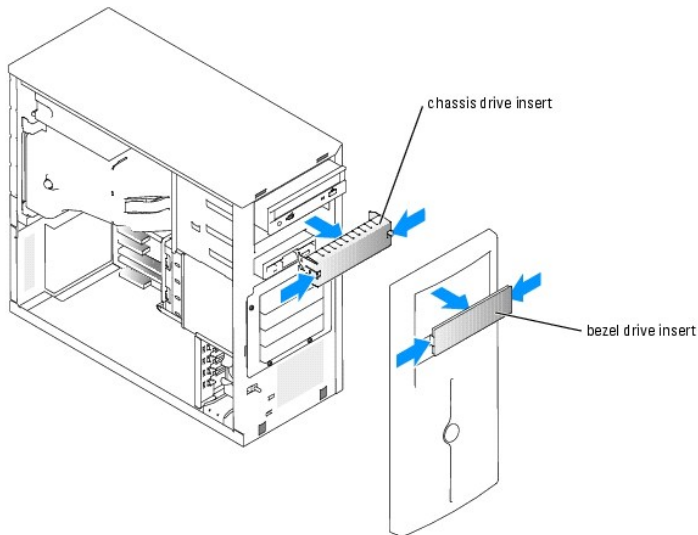

Installing the Front-Panel Drive Inserts

⚠ CAUTION: See your *System Information Guide* for complete information about safety precautions, working inside the computer, and protecting against electrostatic discharge.

➡ NOTICE: You must install both inserts in an empty 5.25-inch drive bay to maintain Federal Communications Commission (FCC) certification of the system. The inserts also help keep dust and dirt out of the system.

1. Install the chassis drive insert by sliding the insert into the chassis until tabs on the side of the insert snap into place. See [Figure 7-1](#).
2. Install the bezel drive insert by sliding the insert into the bezel until the tabs on the side of the insert snap into place. See [Figure 7-1](#).
3. Install the bezel. See "[Installing the Bezel](#)" in "Troubleshooting Your System."

4. Reconnect the system to its electrical outlet and turn the system on, including any attached peripherals.
-

Diskette Drive

Removing a Diskette Drive

 **CAUTION:** See your *Product Information Guide* for complete information about safety precautions, working inside the computer, and protecting against electrostatic discharge.

1. Turn off the system, including any attached peripherals, and disconnect the system from the electrical outlet.
2. Remove the bezel. See "[Removing the Bezel](#)" in "Troubleshooting Your System."
3. Lay the system on its right side.
4. Remove the cover. See "[Removing the Cover](#)" in "Troubleshooting Your System."
5. Disconnect the power cable and the interface cable from the diskette drive. See [Figure 7-2](#).
6. Remove the two screws that secure the diskette drive in the externally accessible drive bay. See [Figure 7-2](#).
7. Slide the diskette drive forward out of the drive bay.

Installing a Diskette Drive

 **CAUTION:** See your *Product Information Guide* for complete information about safety precautions, working inside the computer, and protecting against electrostatic discharge.

1. Unpack the drive and prepare the drive for installation.
For instructions, see the documentation that accompanied the drive.
2. Slide the diskette drive into the externally accessible drive bay.
3. Install the two screws that secure the diskette drive in the drive bay. See [Figure 7-2](#).
4. Connect the power cable and the interface cable to the diskette drive. See [Figure 7-2](#).
5. Install the cover. See "[Replacing the Cover](#)" in "Troubleshooting Your System."
6. Stand the system upright.
7. Install the bezel. See "[Installing the Bezel](#)" in "Troubleshooting Your System."
8. Reconnect the system to its electrical outlet and turn the system on, including any attached peripherals.

Figure 7-2. Removing or Installing a Diskette Drive

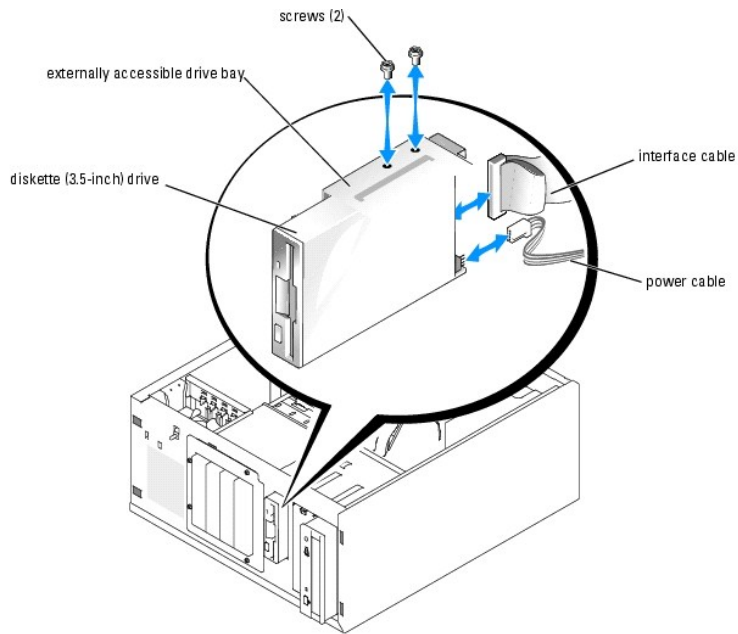

5.25-Inch Drives

An optical drive is standard in the first external drive bay. An additional IDE or SCSI tape backup device can be installed in the second external drive bay. These drives connect either to the system board or to an optional controller card.

NOTE: Installing an additional optical drive in the second external drive bay is not supported.

Installing a 5.25-Inch Drive

CAUTION: See your *Product Information Guide* for complete information about safety precautions, working inside the computer, and protecting against electrostatic discharge.

1. Unpack the drive (and controller card, if applicable), and prepare the drive for installation.

For instructions, see the documentation that accompanied the drive.

NOTE: If you are installing a SCSI tape drive, you must install an Ultra 3 SCSI controller card. The optional SCSI RAID controller card does not support a SCSI tape drive.

2. Turn off the system, including any attached peripherals, and disconnect the system from the electrical outlet.
3. Remove the bezel. See "[Removing the Bezel](#)" in "Troubleshooting Your System."
4. Lay the system on its right side.
5. Remove the cover. See "[Removing the Cover](#)" in "Troubleshooting Your System."
6. Remove the cooling shroud. See "[Removing the Cooling Shroud](#)" in "Installing System Components."
7. Remove the front-panel inserts for the empty external drive bay. See "[Removing the Front-Panel Drive Inserts](#)."
8. Slide the drive into the external drive bay.
9. Install the screws that secure the drive in the drive bay. See [Figure 7-3](#).

Figure 7-3. Installing or Removing a 5.25-Inch Drive

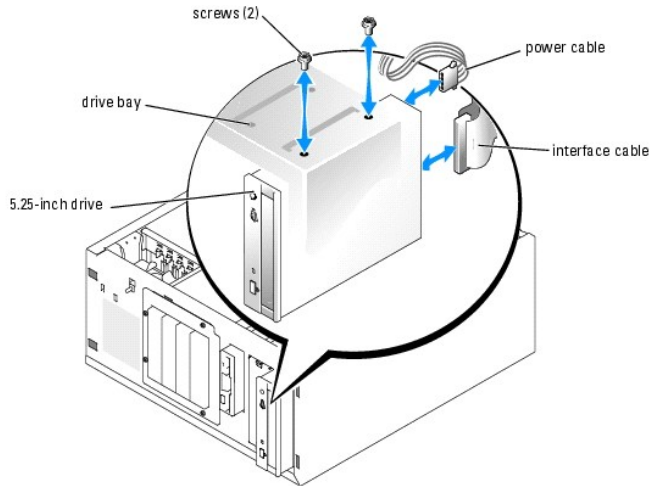

10. If a controller card was supplied with the drive, install the controller card in expansion slot 3, 4, or 5. See "[Installing an Expansion Card](#)" in "Installing System Components."
11. Connect a power cable to the drive. See [Figure 7-3](#).
12. Connect the interface cable to the drive and to the appropriate connector on the system board or controller card (if applicable).

NOTE: See the documentation that is included with the controller card for more information.

If you are installing an IDE device (such as an optical drive), connect the interface cable to the IDE device and the IDE connector on the system board. See [Figure 7-4](#).

If you are installing a SCSI in the second drive bay (such as a tape backup device), connect the interface cable to the device and to channel A on the SCSI controller card. See [Figure 7-4](#).

See [Figure A-3](#) to locate the system board connectors.

NOTE: A SCSI device attached to a SCSI controller card and an IDE device attached to the system board can be installed together as shown in [Figure 7-4](#).

Figure 7-4. Connecting a Tape Drive to a SCSI Controller Card

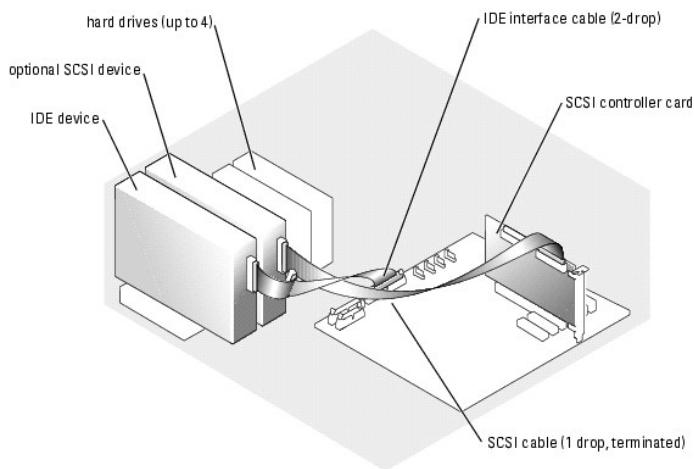

13. Ensure that all cables are firmly connected and arranged so that they will not catch on the computer cover or block airflow inside the system.
14. Install the cooling shroud. See "[Installing the Cooling Shroud](#)" in "Installing System Components."
15. Install the cover. See "[Replacing the Cover](#)" in "Troubleshooting Your System."
16. Stand the system upright.

17. Install the bezel. See "[Installing the Bezel](#)" in "Troubleshooting Your System."
18. Reconnect the system to its electrical outlet and turn the system on, including any attached peripherals.
19. Test the drive.

If you installed an IDE device, run the IDE devices tests in the system diagnostics to determine whether the device operates properly. See "[Running the System Diagnostics](#)."

If you installed a SCSI device, run the SCSI controllers test in the system diagnostics. See "[Running the System Diagnostics](#)."

If you installed a tape drive, see the tape drive software documentation to perform a backup and verification test.

Hard Drives

Your system can contain up to four 1-inch SATA or SCSI hard drives in an optional removable hard-drive bay (see [Figure 7-5](#)). These drives connect either to the system board or to an optional controller card.

General Installation Guidelines

Use the following guidelines when installing hard drives:

- 1 You should only use drives that have been tested and approved by the system manufacturer.
- 1 Do not install a mixture of SATA and SCSI hard drives. All hard drives must either be SCSI drives or SATA drives.
- 1 You may need to use different programs than those provided with the operating system to partition and format a hard drive. See the hard drive's documentation for information on setting up the drive.
- 1 When you format a high-capacity hard drive, allow enough time for the formatting to be completed. Long format times for these drives are normal. For example, a large drive can take over an hour to format.
- 1 Do not turn off or reboot your system while the drive is being formatted. Doing so can cause a drive failure.

 **NOTE:** The hard-drive activity indicator operates only when SATA hard drives are connected directly to the SATA port connectors on the system board. The indicator does not operate with SCSI drives or SATA drives that are attached to a RAID controller card. To identify the indicator, see [Figure 2-1](#).

Configuring the Boot Drive

The drive or device from which the system boots is determined by the boot order specified in the System Setup program (see "Using the System Setup Program" in your *User's Guide*). To boot the system from a hard drive or drive array, the drive(s) must be connected to the appropriate controller:

- 1 To boot from a single SATA hard drive, the master drive (drive 0) must be connected to the SATA_0 connector on the system board. To identify system board connectors, see [Figure A-3](#).
 - 1 To boot from a single SCSI hard drive, the drive must be connected to a SCSI controller card. See the documentation that accompanied the controller card.
-

Cabled SATA and SCSI Hard Drives

Removing a Cabled Hard Drive

 **CAUTION:** See your *Product Information Guide* for complete information about safety precautions, working inside the computer, and protecting against electrostatic discharge.

1. Turn off the system, including any attached peripherals, and disconnect the system from the electrical outlet.
2. Remove the bezel. See "[Removing the Bezel](#)" in "Troubleshooting Your System."
3. Lay the system on its right side.
4. Remove the cover. See "[Removing the Cover](#)" in "Troubleshooting Your System."
5. Remove the cooling shroud. See "[Removing the Cooling Shroud](#)" in "Installing System Components."
6. Disconnect the interface and power cables to the hard drives in the drive bay.

7. Remove the hard-drive bay. See [Figure 7-5](#) and [Figure 7-6](#).
 - a. Loosen the four screws that secure the drive bay to the system.
 - b. Slide the hard-drive bay out of the system.
8. Remove the drive from the drive bay. See [Figure 7-5](#) and [Figure 7-6](#).
 - a. Remove the screws that secure the drive in the hard-drive bay.
 - b. Slide the drive out of the drive bay.

Figure 7-5. Installing or Removing a SATA Hard Drive

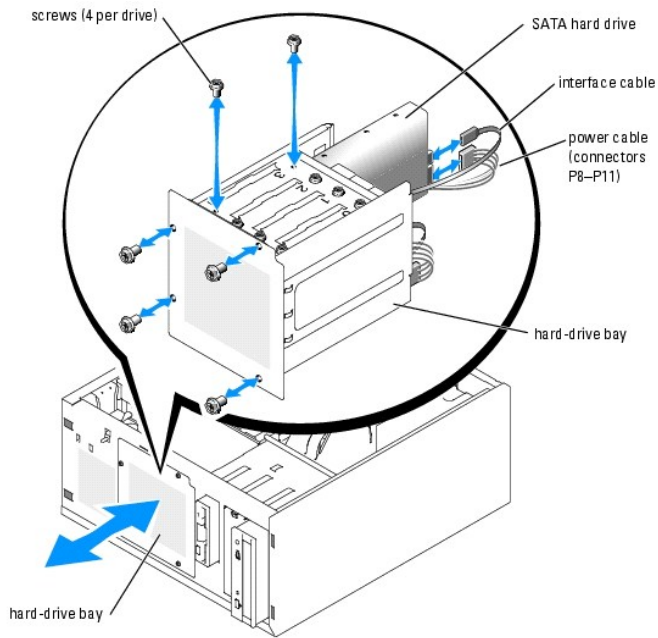
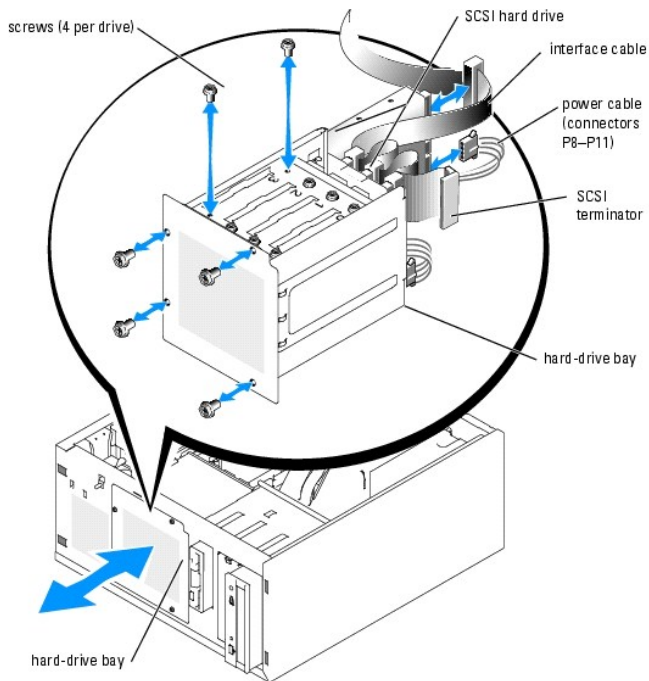

Figure 7-6. Installing or Removing a Cabled SCSI Hard Drive



Installing a Cabled Hard Drive

1. Unpack the drive (and controller card, if applicable), and prepare the drive for installation.

For instructions, see the documentation that accompanied the drive.

2. Install the hard drive in the hard-drive bay:
 - a. Slide the drive into the drive bay with the back of the drive toward the back of the drive bay.
 - b. Install the screws that secure the drive in the drive bay.
3. Install the hard-drive bay (see [Figure 7-5](#) and [Figure 7-6](#)):
 - a. Slide the drive bay into the system until the drive bay contacts the system.
 - b. Install the four screws that secure the drive bay in the system.

NOTICE: To prevent damage to internal system components, ensure that a connector cap is installed on each available power connector that is not connected to a hard drive.

4. Connect a power cable to each hard drive. See [Figure 7-5](#) and [Figure 7-6](#).
5. Connect the hard-drive interface cables to each hard drive.
 - o If you are installing a *SATA hard drive*, connect the SATA interface cable to the hard drives and to the SATA ports on the system board (see [Figure 7-7](#)) or SATA RAID controller board (when available) (see [Figure 7-8](#)).
 - o If you are installing a *cabled SCSI drive*, connect the SCSI interface cable to the hard drives and to the SCSI controller card. See [Figure 7-9](#).

Figure 7-7. Connecting SATA Hard Drives to the Integrated Drive Controller

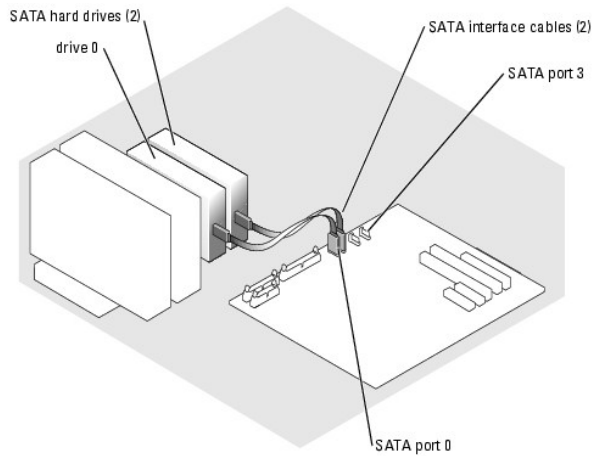

Figure 7-8. Connecting SATA Drives to a SATA RAID Controller Card

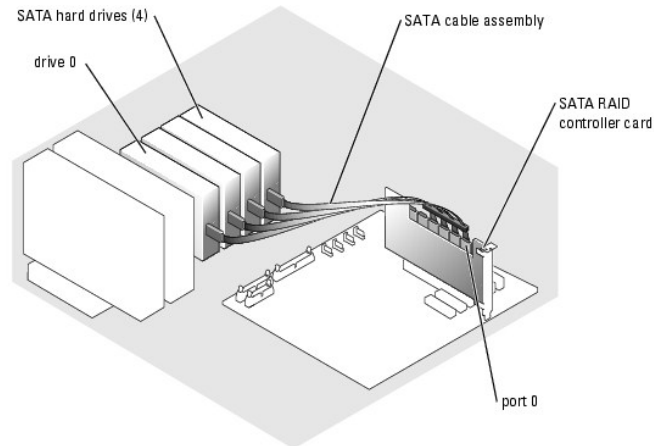
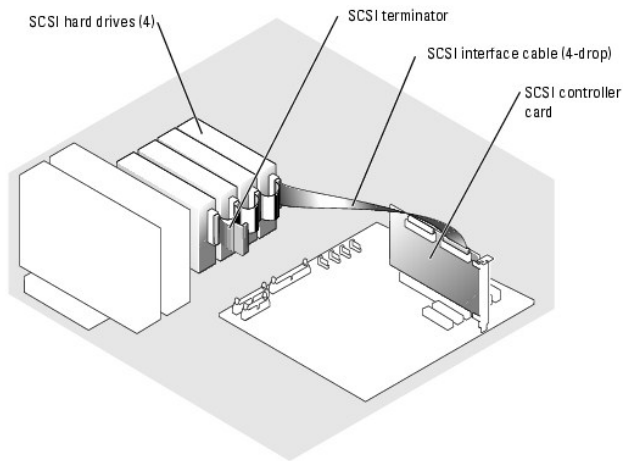

Figure 7-9. Cabling Four SCSI Hard Drives to the SCSI Controller Card



6. Ensure that all cables are firmly connected and arranged so that they will not catch on the computer cover or block airflow inside the system.
7. Install the cooling shroud. See "[Installing the Cooling Shroud](#)" in "Installing System Components."
8. Install the cover. See "[Replacing the Cover](#)" in "Troubleshooting Your System."
9. Stand the system upright.
10. Install the bezel. See "[Installing the Bezel](#)" in "Troubleshooting Your System."
11. Reconnect the system to its electrical outlet and turn the system on, including any attached peripherals.
12. Partition and logically format the hard drive. See the operating system documentation for more information.
13. Install any required device drivers.
14. Run the hard drive tests in the system diagnostics to determine whether the drive operates properly. See "[Running the System Diagnostics](#)."

If the drive is connected to a SATA RAID controller card, see the RAID controller card documentation for information on testing the controller.

If the drive is connected to a SCSI controller card, run the SCSI controller tests and the hard-drive tests in the system diagnostics. See "[Running the System Diagnostics](#)."

If the hard drive fails the hard-drive tests or does not operate properly, see "[Getting Help](#)."

Front-Access SCSI Hard Drives (Non-Hot-Plug)

The drive bays in a system with an optional SCSI backplane board and optional non-RAID SCSI controller card provide space for up to four front-access SCSI hard drives. The hard drives plug into the SCSI backplane board, which is connected to the controller card (see [Figure 7-10](#).) For instructions on installing the optional SCSI backplane board, see "[Installing the Optional SCSI Backplane Board](#)."

Figure 7-10. SCSI Hard Drives Connected to a SCSI Controller Card

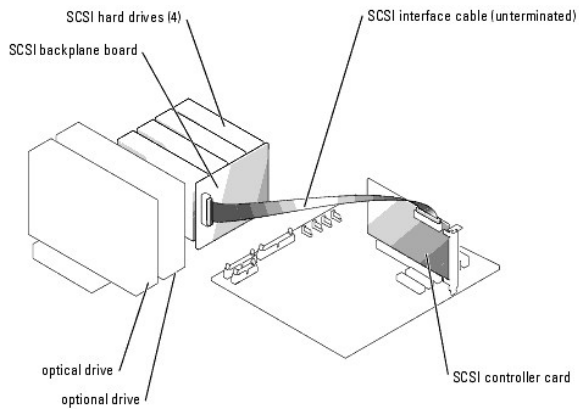

Removing a Front-Access SCSI Hard Drive (Non-Hot-Plug)

➔ **NOTICE:** To prevent data loss, you must shut down the system before removing a SCSI drive carrier, unless a SCSI RAID controller is connected to the SCSI backplane. See "[Hot-Plug SCSI Hard Drives](#)" for information on hot-plug drive requirements and operation.

1. Turn off the system, including any attached peripherals, and disconnect the system from the electrical outlet.
2. Remove the bezel. See "[Removing the Bezel](#)" in "Troubleshooting Your System."
3. Open the hard-drive carrier handle to release the drive. See [Figure 7-11](#).
4. Slide the hard drive out until it is free of the drive bay.

Figure 7-11. Removing or Installing a SCSI Hard-Drive Carrier

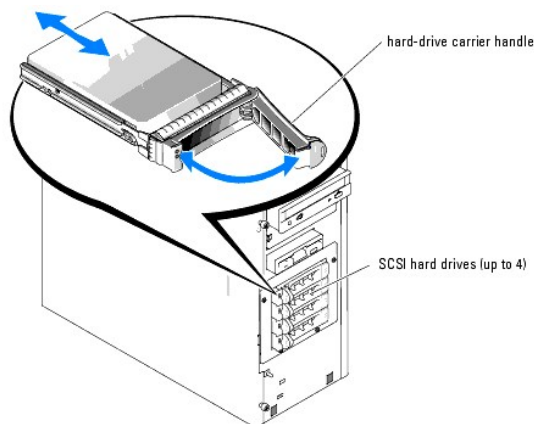

Installing a Front-Access SCSI Hard Drive (Non-Hot-Plug)

1. Turn off the system, including any attached peripherals, and disconnect the system from the electrical outlet.
2. Remove the bezel. See "[Removing the Bezel](#)" in "Troubleshooting Your System."
3. Open the hard-drive carrier handle. See [Figure 7-11](#).
- ➔ **NOTICE:** Do not insert a hard-drive carrier and attempt to lock its handle next to a partially installed carrier. Doing so can damage the partially installed carrier's shield spring and make it unusable. Ensure that the adjacent drive carrier is fully installed.
4. Insert the hard-drive carrier into the drive bay. See [Figure 7-11](#).
5. Close the hard-drive carrier handle to lock it in place.

6. Install the bezel. See "[Installing the Bezel](#)" in "Troubleshooting Your System."
 7. Reconnect the system to its electrical outlet and turn the system on, including any attached peripherals.
 8. Install any required SCSI device drivers.
 9. Run the SCSI controllers tests and the hard-drive tests in the system diagnostics. See "[Running the System Diagnostics](#)."
- If the hard drive fails the hard-drive tests or does not operate properly, see "[Getting Help](#)."

Hot-Plug SCSI Hard Drives

Systems with an optional SCSI backplane board and an optional SCSI RAID controller card support up to four hot-plug hard drives. The hard drives plug into the SCSI backplane board, which is connected to channel A on the optional SCSI RAID controller card (see [Figure 7-12](#)). For instructions on installing the optional SCSI backplane board, see "[Installing the Optional SCSI Backplane Board](#)."

Figure 7-12. Hot-Plug SCSI Hard Drives Connected to a SCSI RAID Controller Card

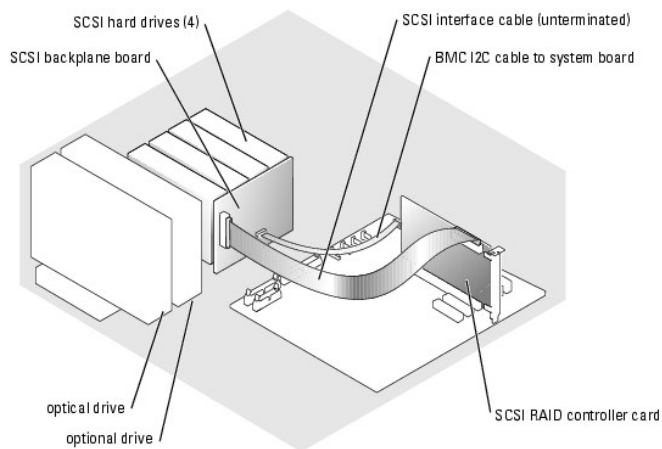

Removing a Hot-Plug SCSI Hard Drive

NOTICE: Not all operating systems support hot-plug drive installation. See the operating system documentation to confirm that the operating system supports this feature.

1. Remove the bezel. See "[Removing the Bezel](#)" in "Troubleshooting Your System."
2. Take the hard drive offline and wait until the hard-drive indicator codes on the drive carrier signal that the drive can be removed safely. See [Table 2-3](#) for a list of hard-drive indicator codes.

If the drive has been online, the drive status indicator will blink green 2 times per second as the drive is powered down. When all indicators are off, the drive is ready for removal.

See your operating system documentation for more information on taking the hard drive offline.

3. Open the hard-drive carrier handle to release the drive. See [Figure 7-11](#).
4. Slide the hard drive out until it is free of the drive bay.

Installing a Hot-Plug SCSI Hard Drive

1. Remove the bezel. See "[Removing the Bezel](#)" in "Troubleshooting Your System."
2. Open the hard-drive carrier handle. See [Figure 7-11](#).

NOTICE: Do not insert a hard-drive carrier and attempt to lock its handle next to a partially installed carrier. Doing so can damage the partially installed carrier's shield spring and make it unusable. Ensure that the adjacent drive carrier is fully installed.

3. Insert the hard-drive carrier into the drive bay. See [Figure 7-11](#).
 4. Close the hard-drive carrier handle to lock it in place.
 5. Install the bezel. See "[Installing the Bezel](#)" in "Troubleshooting Your System."
 6. Install any required SCSI device drivers.
 7. Run the SCSI controllers tests and the hard-drive tests in the system diagnostics. See "[Running the System Diagnostics](#)."
- If the hard drive fails the hard-drive tests or does not operate properly, see "[Getting Help](#)."
-

Installing the Optional SCSI Backplane Board

The optional SCSI backplane board supports front-access SCSI drives (if an optional SCSI controller card is installed in the system) or hot-plug SCSI drives (if an optional RAID controller card is installed in the system). A new drive cage is supplied with the SCSI backplane.

⚠ CAUTION: See the *Product Information Guide* for complete information about safety precautions, working inside the computer, and protecting against electrostatic discharge.

1. Turn off the system, including any attached peripherals, and disconnect the system from the electrical outlet.
2. Remove the bezel. See "[Removing the Bezel](#)" in "Troubleshooting Your System."
3. Lay the system on its right side.
4. Remove the cover. See "[Removing the Cover](#)" in "Troubleshooting Your System."
5. Remove the cooling shroud. See "[Removing the Cooling Shroud](#)" in "Installing System Components."
6. Disconnect the SATA or SCSI interface cables from the hard drives.
7. Disconnect the wiring harness from power cable connector P3.
8. Remove the hard-drive bay from the system. See [Figure 7-6](#).
 - a. Loosen the four screws that secure the drive bay to the system.
Retain the screws to use when installing the new drive cage.
 - b. Slide the hard-drive bay out of the system.
9. Slide the new drive cage into the system and secure it with the four Phillips screws you removed in [step 8](#).
10. Install the SCSI backplane:
 - a. Lower the backplane into the system and align the backplane with the retention hooks on the drive cage, then fit the backplane over the retention hooks.
 - b. Slide the backplane board toward the front fan about 12 mm (0.5 inch).
 - c. Secure the backplane with the thumbscrew. See [Figure 7-13](#).

Figure 7-13. Installing the SCSI Backplane Board

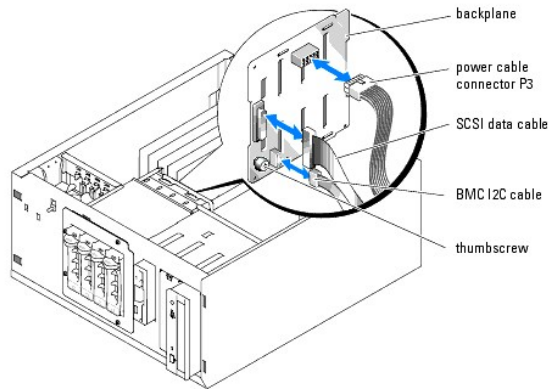

11. Connect the power cable connector P3 to the power connector on the SCSI backplane. See [Figure 7-13](#).
12. Connect the baseboard management controller (BMC) inter-IC (I2C) cable to the SCSI backplane. See [Figure 7-13](#).
13. Connect the other end of the BMC I2C cable to connector BP_I2C on the system board. See [Figure A-3](#).
14. Install the SCSI controller card.
See "[Installing an Expansion Card](#)" in "Installing System Components" for instructions about installing the card.
15. Connect the SCSI data cable to the SCSI controller card, and to the SCSI interface connector on the backplane. See [Figure 7-12](#) and [Figure 7-13](#).
16. Install the cover. See "[Replacing the Cover](#)" in "Troubleshooting Your System."
17. Stand the system upright.
18. Install the SCSI drives into the hard-drive bay.
See [Figure 7-11](#).
19. Install the bezel. See "[Installing the Bezel](#)" in "Troubleshooting Your System."
20. Reconnect the system to its electrical outlet and turn the system on, including any attached peripherals.
21. Install any required SCSI device drivers.
22. Run the SCSI controllers tests and the hard-drive tests in the system diagnostics. See "[Running the System Diagnostics](#)."

Installing a RAID Controller Card

See "[Installing an Expansion Card](#)" in "Installing System Components" for instructions about installing the card.

[Back to Contents Page](#)

[Back to Contents Page](#)

Getting Help

Dell™ PowerEdge™ 800 Systems Installation and Troubleshooting Guide

- [Technical Assistance](#)
 - [Dell Enterprise Training and Certification](#)
 - [Problems With Your Order](#)
 - [Product Information](#)
 - [Returning Items for Warranty Repair or Credit](#)
 - [Before You Call](#)
 - [Contacting Dell](#)
-

Technical Assistance

If you need assistance with a technical problem, perform the following steps:

1. Complete the procedures in "[Troubleshooting Your System](#)."
2. Run the system diagnostics and record any information provided.
3. Make a copy of the [Diagnostics Checklist](#), and fill it out.
4. Use Dell's extensive suite of online services available at Dell Support at support.dell.com for help with installation and troubleshooting procedures.

For more information, see "[Online Services](#)."

5. If the preceding steps have not resolved the problem, call Dell for technical assistance.

NOTE: Call technical support from a phone near or at the system so that technical support can assist you with any necessary procedures.

NOTE: Dell's Express Service Code system may not be available in all countries.

When prompted by Dell's automated telephone system, enter your Express Service Code to route the call directly to the proper support personnel. If you do not have an Express Service Code, open the **Dell Accessories** folder, double-click the **Express Service Code** icon, and follow the directions.

For instructions on using the technical support service, see "[Technical Support Service](#)" and "[Before You Call](#)."

NOTE: Some of the following services are not always available in all locations outside the continental U.S. Call your local Dell representative for information on availability.

Online Services

You can access Dell Support at support.dell.com. Select your region on the **WELCOME TO DELL SUPPORT** page, and fill in the requested details to access help tools and information.

You can contact Dell electronically using the following addresses:

- 1 World Wide Web

www.dell.com/

www.dell.com/ap/ (Asian/Pacific countries only)

www.dell.com/jp (Japan only)

www.euro.dell.com (Europe only)

www.dell.com/la (Latin American countries)

www.dell.ca (Canada only)

- 1 Anonymous file transfer protocol (FTP)

[ftp.dell.com/](ftp://ftp.dell.com/)

Log in as user:anonymous, and use your e-mail address as your password.

- 1 Electronic Support Service

support@us.dell.com

apsupport@dell.com (Asian/Pacific countries only)

support.jp.dell.com (Japan only)

support.euro.dell.com (Europe only)

1 Electronic Quote Service

sales@dell.com

apmarketing@dell.com (Asian/Pacific countries only)

sales_canada@dell.com (Canada only)

1 Electronic Information Service

info@dell.com

AutoTech Service

Dell's automated technical support service—AutoTech—provides recorded answers to the questions most frequently asked by Dell customers about their portable and desktop computer systems.

When you call AutoTech, use your touch-tone telephone to select the subjects that correspond to your questions.

The AutoTech service is available 24 hours a day, 7 days a week. You can also access this service through the technical support service. See the contact information for your region.

Automated Order-Status Service

To check on the status of any Dell™ products that you have ordered, you can go to **support.dell.com**, or you can call the automated order-status service. A recording prompts you for the information needed to locate and report on your order. See the contact information for your region.

Technical Support Service

Dell's technical support service is available 24 hours a day, 7 days a week, to answer your questions about Dell hardware. Our technical support staff use computer-based diagnostics to provide fast, accurate answers.

To contact Dell's technical support service, see "[Before You Call](#)" and then see the contact information for your region.

Dell Enterprise Training and Certification

Dell Enterprise Training and Certification is available; see www.dell.com/training for more information. This service may not be offered in all locations.

Problems With Your Order

If you have a problem with your order, such as missing parts, wrong parts, or incorrect billing, contact Dell for customer assistance. Have your invoice or packing slip available when you call. See the contact information for your region.

Product Information

If you need information about additional products available from Dell, or if you would like to place an order, visit the Dell website at www.dell.com. For the telephone number to call to speak to a sales specialist, see the contact information for your region.

Returning Items for Warranty Repair or Credit

Prepare all items being returned, whether for repair or credit, as follows:

1. Call Dell to obtain a Return Material Authorization Number, and write it clearly and prominently on the outside of the box.

For the telephone number to call, see the contact information for your region.

2. Include a copy of the invoice and a letter describing the reason for the return.

3. Include a copy of any diagnostic information (including the Diagnostics Checklist) indicating the tests you have run and any error messages reported by

the system diagnostics.

4. Include any accessories that belong with the item(s) being returned (such as power cables, media such as CDs and diskettes, and guides) if the return is for credit.
5. Pack the equipment to be returned in the original (or equivalent) packing materials.

You are responsible for paying shipping expenses. You are also responsible for insuring any product returned, and you assume the risk of loss during shipment to Dell. Collect-on-delivery (C.O.D.) packages are not accepted.

Returns that are missing any of the preceding requirements will be refused at our receiving dock and returned to you.

Before You Call

NOTE: Have your Express Service Code ready when you call. The code helps Dell's automated-support telephone system direct your call more efficiently.

Remember to fill out the [Diagnostics Checklist](#). If possible, turn on your system before you call Dell for technical assistance and call from a telephone at or near the computer. You may be asked to type some commands at the keyboard, relay detailed information during operations, or try other troubleshooting steps possible only at the computer system itself. Ensure that the system documentation is available.

 **CAUTION:** Before servicing any components inside your computer, see your *Product Information Guide* for important safety information.

Diagnostics Checklist
Name:
Date:
Address:
Phone number:
Service Tag (bar code on the back of the computer):
Express Service Code:
Return Material Authorization Number (if provided by Dell support technician):
Operating system and version:
Peripherals:
Expansion cards:
Are you connected to a network? Yes No
Network, version, and network card:
Programs and versions:
See your operating system documentation to determine the contents of the system's start-up files. If possible, print each file. Otherwise, record the contents of each file before calling Dell.
Error message, beep code, or diagnostic code:
Description of problem and troubleshooting procedures you performed:

Contacting Dell

To contact Dell™ electronically, you can access the following websites:

- 1 www.dell.com
- 1 support.dell.com (technical support)
- 1 premiersupport.dell.com (technical support for educational, government, healthcare, and medium/large business customers, including Premier, Platinum, and Gold customers)

For specific web addresses for your country, find the appropriate country section in the table below.

 **NOTE:** Toll-free numbers are for use within the country for which they are listed.

When you need to contact Dell, use the electronic addresses, telephone numbers, and codes provided in the following table. If you need assistance in determining which codes to use, contact a local or an international operator.

	Department Name or Service Area, Website and E-Mail Address	Area Codes, Local Numbers, and
--	--	-----------------------------------

Country (City) International Access Code Country Code City Code		Toll-Free Numbers
Anguilla	General Support	toll-free: 800-335-0031
Antigua and Barbuda	General Support	1-800-805-5924
Argentina (Buenos Aires)	Website: www.dell.com.ar	
International Access Code: 00	E-mail: us_latin_services@dell.com	
Country Code: 54	E-mail for desktop and portable computers: la-techsupport@dell.com	
City Code: 11	E-mail for servers and EMC: la_enterprise@dell.com	
	Customer Care	toll-free: 0-800-444-0730
	Tech Support	toll-free: 0-800-444-0733
	Tech Support Services	toll-free: 0-800-444-0724
	Sales	0-810-444-3355
Aruba	General Support	toll-free: 800-1578
Australia (Sydney)	E-mail (Australia): au_tech_support@dell.com	
International Access Code: 0011	E-mail (New Zealand): nz_tech_support@dell.com	
Country Code: 61	Home and Small Business	1-300-655-533
City Code: 2	Government and Business	toll-free: 1-800-633-559
	Preferred Accounts Division (PAD)	toll-free: 1-800-060-889
	Customer Care	toll-free: 1-800-819-339
	Technical Support (portables and desktops)	toll-free: 1-300-655-533
	Technical Support (servers and workstations)	toll-free: 1-800-733-314
	Corporate Sales	toll-free: 1-800-808-385
	Transaction Sales	toll-free: 1-800-808-312
	Fax	toll-free: 1-800-818-341
Austria (Vienna)	Website: support.euro.dell.com	
International Access Code: 900	E-mail: tech_support_central_europe@dell.com	
Country Code: 43	Home/Small Business Sales	0820 240 530 00
City Code: 1	Home/Small Business Fax	0820 240 530 49
	Home/Small Business Customer Care	0820 240 530 14
	Preferred Accounts/Corporate Customer Care	0820 240 530 16
	Home/Small Business Technical Support	0820 240 530 14
	Preferred Accounts/Corporate Technical Support	0660 8779
	Switchboard	0820 240 530 00
Bahamas	General Support	toll-free: 1-866-278-6818
Barbados	General Support	1-800-534-3066
Belgium (Brussels)	Website: support.euro.dell.com	
International Access Code: 00	E-mail for French Speaking Customers: support.euro.dell.com/be/fr/emaildell/	
Country Code: 32	Technical Support	02 481 92 88
City Code: 2	Technical Support Fax	02 481 92 95
	Customer Care	02 713 15 .65
	Corporate Sales	02 481 91 00
	Fax	02 481 92 99
	Switchboard	02 481 91 00
Bermuda	General Support	1-800-342-0671
Bolivia	General Support	toll-free: 800-10-0238
Brazil	Website: www.dell.com/br	
International Access Code: 00	Customer Support, Technical Support	0800 90 3355
Country Code: 55	Technical Support Fax	51 481 5470
City Code: 51	Customer Care Fax	51 481 5480
	Sales	0800 90 3390
British Virgin Islands	General Support	toll-free: 1-866-278-6820
Brunei	Customer Technical Support (Penang, Malaysia)	604 633 4966
Country Code: 673	Customer Service (Penang, Malaysia)	604 633 4949
	Transaction Sales (Penang, Malaysia)	604 633 4955
Canada (North York, Ontario)	Online Order Status: www.dell.ca/ostatus	
International Access Code:	AutoTech (automated technical support)	toll-free: 1-800-247-9362

011	Customer Care (Home Sales/Small Business)	toll-free: 1-800-847-4096
	Customer Care (med./large business, government)	toll-free: 1-800-326-9463
	Technical Support (Home Sales/Small Business)	toll-free: 1-800-847-4096
	Technical Support (med./large bus., government)	toll-free: 1-800-387-5757
	Sales (Home Sales/Small Business)	toll-free: 1-800-387-5752
	Sales (med./large bus., government)	toll-free: 1-800-387-5755
	Spare Parts Sales & Extended Service Sales	1 866 440 3355
Cayman Islands	General Support	1-800-805-7541
Chile (Santiago) Country Code: 56 City Code: 2	Sales, Customer Support, and Technical Support	toll-free: 1230-020-4823
China (Xiamen) Country Code: 86 City Code: 592	Technical Support website: support.dell.com.cn	
	Technical Support E-mail: cn_support@dell.com	
	Customer Care E-mail: customer_cn@dell.com	
	Technical Support Fax	818 1350
	Technical Support (Dimension™ and Inspiron™)	toll-free: 800 858 2969
	Technical Support (OptiPlex™, Latitude™, and Dell Precision™)	toll-free: 800 858 0950
	Technical Support (servers and storage)	toll-free: 800 858 0960
	Technical Support (projectors, PDAs, printers, switches, routers, and so on)	toll-free: 800 858 2920
	Customer Care	toll-free: 800 858 2060
	Customer Care Fax	592 818 1308
	Home and Small Business	toll-free: 800 858 2222
	Preferred Accounts Division	toll-free: 800 858 2557
	Large Corporate Accounts GCP	toll-free: 800 858 2055
	Large Corporate Accounts Key Accounts	toll-free: 800 858 2628
	Large Corporate Accounts North	toll-free: 800 858 2999
	Large Corporate Accounts North Government and Education	toll-free: 800 858 2955
	Large Corporate Accounts East	toll-free: 800 858 2020
	Large Corporate Accounts East Government and Education	toll-free: 800 858 2669
	Large Corporate Accounts Queue Team	toll-free: 800 858 2572
Large Corporate Accounts South	toll-free: 800 858 2355	
Large Corporate Accounts West	toll-free: 800 858 2811	
Large Corporate Accounts Spare Parts	toll-free: 800 858 2621	
Colombia	General Support	980-9-15-3978
Costa Rica	General Support	0800-012-0435
Czech Republic (Prague) International Access Code: 00 Country Code: 420	Website: support.euro.dell.com	
	E-mail: czech_dell@dell.com	
	Technical Support	22537 2727
	Customer Care	22537 2707
	Fax	22537 2714
	Tech Fax	22537 2728
	Switchboard	22537 2711
Denmark (Copenhagen) International Access Code: 00 Country Code: 45	Website: support.euro.dell.com	
	E-mail: http://support.euro.dell.com/dk/da/emaildell/	
	Technical Support	7023 0182
	Customer Care (Relational)	7023 0184
	Home/Small Business Customer Care	3287 5505
	Switchboard (Relational)	3287 1200
	Switchboard Fax (Relational)	3287 1201
	Switchboard (Home/Small Business)	3287 5000
Switchboard Fax (Home/Small Business)	3287 5001	
Dominica	General Support	toll-free: 1-866-278-6821
Dominican Republic	General Support	1-800-148-0530
Ecuador	General Support	toll-free: 999-119
El Salvador	General Support	01-899-753-0777
Finland (Helsinki)	Website: support.euro.dell.com	

International Access Code: 990	E-mail: http://support.euro.dell.com/fi/fi/emaildell/	
	Technical Support	09 253 313 60
Country Code: 358	Customer Care	09 253 313 38
	Fax	09 253 313 99
City Code: 9	Switchboard	09 253 313 00
France (Paris) (Montpellier)	Website: support.euro.dell.com	
International Access Code: 00	E-mail: support.euro.dell.com/fr/fr/emaildell/	
	Home and Small Business	
Country Code: 33	Technical Support	0825 387 270
	Customer Care	0825 823 833
City Codes: (1) (4)	Switchboard	0825 004 700
	Switchboard (calls from outside of France)	04 99 75 40 00
	Sales	0825 004 700
	Fax	0825 004 701
	Fax (calls from outside of France)	04 99 75 40 01
	Corporate	
	Technical Support	0825 004 719
	Customer Care	0825 338 339
	Switchboard	01 55 94 71 00
	Sales	01 55 94 71 00
	Fax	01 55 94 71 01
Germany (Langen)	Website: support.euro.dell.com	
International Access Code: 00	E-mail: tech_support_central_europe@dell.com	
	Technical Support	06103 766-7200
Country Code: 49	Home/Small Business Customer Care	0180-5-224400
	Global Segment Customer Care	06103 766-9570
City Code: 6103	Preferred Accounts Customer Care	06103 766-9420
	Large Accounts Customer Care	06103 766-9560
	Public Accounts Customer Care	06103 766-9555
	Switchboard	06103 766-7000
Greece	Website: support.euro.dell.com	
International Access Code: 00	E-mail: support.euro.dell.com/gr/en/emaildell/	
	Technical Support	00800-44 14 95 18
Country Code: 30	Gold Service Technical Support	00800-44 14 00 83
	Switchboard	2108129810
	Gold Service Switchboard	2108129811
	Sales	2108129800
	Fax	2108129812
Grenada	General Support	toll-free: 1-866-540-3355
Guatemala	General Support	1-800-999-0136
Guyana	General Support	toll-free: 1-877-270-4609
Hong Kong	Website: support.ap.dell.com	
International Access Code: 001	Technical Support E-mail: apsupport@dell.com	
	Technical Support (Dimension and Inspiron)	2969 3188
Country Code: 852	Technical Support (OptiPlex, Latitude, and Dell Precision)	2969 3191
	Technical Support (PowerApp™, PowerEdge™, PowerConnect™, and PowerVault™)	2969 3196
	Customer Care	3416 0910
	Large Corporate Accounts	3416 0907
	Global Customer Programs	3416 0908
	Medium Business Division	3416 0912
	Home and Small Business Division	2969 3105
India	Technical Support	1600 33 8045
	Sales (Large Corporate Accounts)	1600 33 8044
	Sales (Home and Small Business)	1600 33 8046
Ireland (Cherrywood)	Website: support.euro.dell.com	
International Access Code: 16	E-mail: dell_direct_support@dell.com	
	Technical Support	1850 543 543
Country Code: 353	U.K. Technical Support (dial within U.K. only)	0870 908 0800

City Code: 1	Home User Customer Care	01 204 4014
	Small Business Customer Care	01 204 4014
	U.K. Customer Care (dial within U.K. only)	0870 906 0010
	Corporate Customer Care	1850 200 982
	Corporate Customer Care (dial within U.K. only)	0870 907 4499
	Ireland Sales	01 204 4444
	U.K. Sales (dial within U.K. only)	0870 907 4000
	Fax/Sales Fax	01 204 0103
	Switchboard	01 204 4444
Italy (Milan) International Access Code: 00 Country Code: 39 City Code: 02	Website: support.euro.dell.com	
	E-mail: support.euro.dell.com/it/it/emaidell/	
	Home and Small Business	
	Technical Support	02 577 826 90
	Customer Care	02 696 821 14
	Fax	02 696 821 13
	Switchboard	02 696 821 12
	Corporate	
	Technical Support	02 577 826 90
	Customer Care	02 577 825 55
	Fax	02 575 035 30
	Switchboard	02 577 821
	Jamaica	General Support (dial from within Jamaica only)
Japan (Kawasaki) International Access Code: 001 Country Code: 81 City Code: 44	Website: support.jp.dell.com	
	Technical Support (servers)	toll-free: 0120-198-498
	Technical Support outside of Japan (servers)	81-44-556-4162
	Technical Support (Dimension and Inspiron)	toll-free: 0120-198-226
	Technical Support outside of Japan (Dimension and Inspiron)	81-44-520-1435
	Technical Support (Dell Precision, OptiPlex, and Latitude)	toll-free: 0120-198-433
	Technical Support outside of Japan (Dell Precision, OptiPlex, and Latitude)	81-44-556-3894
	Technical Support (PDAs, projectors, printers, routers)	toll-free: 0120-981-690
	Technical Support outside of Japan (PDAs, projectors, printers, routers)	81-44-556-3468
	Faxbox Service	044-556-3490
	24-Hour Automated Order Service	044-556-3801
	Customer Care	044-556-4240
	Business Sales Division (up to 400 employees)	044-556-1465
	Preferred Accounts Division Sales (over 400 employees)	044-556-3433
	Large Corporate Accounts Sales (over 3500 employees)	044-556-3430
	Public Sales (government agencies, educational institutions, and medical institutions)	044-556-1469
	Global Segment Japan	044-556-3469
	Individual User	044-556-1760
	Switchboard	044-556-4300
Korea (Seoul) International Access Code: 001 Country Code: 82 City Code: 2	Technical Support	toll-free: 080-200-3800
	Sales	toll-free: 080-200-3600
	Customer Service (Penang, Malaysia)	604 633 4949
	Fax	2194-6202
	Switchboard	2194-6000
Latin America	Technical Support (Electronics and Accessories)	toll-free: 080-200-3801
	Customer Technical Support (Austin, Texas, U.S.A.)	512 728-4093
	Customer Service (Austin, Texas, U.S.A.)	512 728-3619
	Fax (Technical Support and Customer Service) (Austin, Texas, U.S.A.)	512 728-3883
	Sales (Austin, Texas, U.S.A.)	512 728-4397
	SalesFax (Austin, Texas, U.S.A.)	512 728-4600
		or 512 728-3772
Luxembourg International Access Code: 00 Country Code: 352	Website: support.euro.dell.com	
	E-mail: tech_be@dell.com	
	Technical Support (Brussels, Belgium)	3420808075
	Home/Small Business Sales (Brussels, Belgium)	toll-free: 080016884
	Corporate Sales (Brussels, Belgium)	02 481 91 00

	Customer Care (Brussels, Belgium)	02 481 91 19
	Fax (Brussels, Belgium)	02 481 92 99
	Switchboard (Brussels, Belgium)	02 481 91 00
Macao	Technical Support	toll-free: 0800 105
Country Code: 853	Customer Service (Xiamen, China)	34 160 910
	Transaction Sales (Xiamen, China)	29 693 115
Malaysia (Penang)	Website: support.ap.dell.com	toll-free: 1 800 88 0193
International Access Code: 00	Technical Support (Dell Precision, OptiPlex, and Latitude)	toll-free: 1 800 88 1306
Country Code: 60	Technical Support (Dimension, Inspiron, and Electronics and Accessories)	
City Code: 4	Technical Support (PowerApp, PowerEdge, PowerConnect, and PowerVault)	toll-free: 1800 88 1386
	Customer Service (Penang, Malaysia)	04 633 4949
	Transaction Sales	toll-free: 1 800 888 202
	Corporate Sales	toll-free: 1 800 888 213
Mexico	Customer Technical Support	001-877-384-8979 or 001-877-269-3383
International Access Code: 00	Sales	50-81-8800 or 01-800-888-3355
Country Code: 52	Customer Service	001-877-384-8979 or 001-877-269-3383
	Main	50-81-8800 or 01-800-888-3355
Montserrat	General Support	toll-free: 1-866-278-6822
Netherlands Antilles	General Support	001-800-882-1519
Netherlands (Amsterdam)	Website: support.euro.dell.com	
International Access Code: 00	Technical Support	020 674 45 00
Country Code: 31	Technical Support Fax	020 674 47 66
City Code: 20	Home/Small Business Customer Care	020 674 42 00
	Relational Customer Care	020 674 4325
	Home/Small Business Sales	020 674 55 00
	Relational Sales	020 674 50 00
	Home/Small Business Sales Fax	020 674 47 75
	Relational Sales Fax	020 674 47 50
	Switchboard	020 674 50 00
	Switchboard Fax	020 674 47 50
New Zealand	E-mail (New Zealand): nz_tech_support@dell.com	
International Access Code: 00	E-mail (Australia): au_tech_support@dell.com	
Country Code: 64	Technical Support (for desktop and portable computers)	toll-free: 0800 446 255
	Technical Support (for servers and workstations)	toll-free: 0800 443 563
	Home and Small Business	0800 446 255
	Government and Business	0800 444 617
	Sales	0800 441 567
	Fax	0800 441 566
Nicaragua	General Support	001-800-220-1006
Norway (Lysaker)	Website: support.euro.dell.com	
International Access Code: 00	E-mail: http://support.euro.dell.com/no/no/emaildell/	
Country Code: 47	Technical Support	671 16882
	Relational Customer Care	671 17575
	Home/Small Business Customer Care	23162298
	Switchboard	671 16800
	Fax Switchboard	671 16865
Panama	General Support	001-800-507-0962
Peru	General Support	0800-50-669
Poland (Warsaw)	Website: support.euro.dell.com	
International Access Code: 011	E-mail: pl_support_tech@dell.com	
Country Code: 48	Customer Service Phone	57 95 700
City Code: 22	Customer Care	57 95 999
	Sales	57 95 999
	Customer Service Fax	57 95 806

	Reception Desk Fax	57 95 998
	Switchboard	57 95 999
Portugal	Website: support.euro.dell.com	
International Access Code: 00	E-mail: support.euro.dell.com/pt/en/emaildell/	
Country Code: 351	Technical Support	707200149
	Customer Care	800 300 413
	Sales	800 300 410 or 800 300 411 or 800 300 412 or 21 422 07 10
	Fax	21 424 01 12
Puerto Rico	General Support	1-800-805-7545
St. Kitts and Nevis	General Support	toll-free: 1-877-441-4731
St. Lucia	General Support	1-800-882-1521
St. Vincent and the Grenadines	General Support	toll-free: 1-877-270-4609
Singapore (Singapore)	Website: support.ap.dell.com	
International Access Code: 005	Technical Support (Dimension, Inspiron, and Electronics and Accessories)	toll-free: 1800 394 7430
Country Code: 65	Technical Support (OptiPlex, Latitude, and Dell Precision)	toll-free: 1800 394 7488
	Technical Support (PowerApp, PowerEdge, PowerConnect, and PowerVault)	toll-free: 1800 394 7478
	Customer Service (Penang, Malaysia)	604 633 4949
	Transaction Sales	toll-free: 1 800 394 7412
	Corporate Sales	toll-free: 1 800 394 7419
Slovakia (Prague)	Website: support.euro.dell.com	
International Access Code: 00	E-mail: czech_dell@dell.com	
Country Code: 421	Technical Support	02 5441 5727
	Customer Care	420 22537 2707
	Fax	02 5441 8328
	Tech Fax	02 5441 8328
	Switchboard (Sales)	02 5441 7585
South Africa (Johannesburg)	Website: support.euro.dell.com	
International Access Code: 09/091	E-mail: dell_za_support@dell.com	
Country Code: 27	Gold Queue	011 709 7713
City Code: 11	Technical Support	011 709 7710
	Customer Care	011 709 7707
	Sales	011 709 7700
	Fax	011 706 0495
	Switchboard	011 709 7700
Southeast Asian and Pacific Countries	Customer Technical Support, Customer Service, and Sales (Penang, Malaysia)	604 633 4810
Spain (Madrid)	Website: support.euro.dell.com	
International Access Code: 00	E-mail: support.euro.dell.com/es/es/emaildell/	
Country Code: 34	Home and Small Business	
City Code: 91	Technical Support	902 100 130
	Customer Care	902 118 540
	Sales	902 118 541
	Switchboard	902 118 541
	Fax	902 118 539
	Corporate	
	Technical Support	902 100 130
	Customer Care	902 115 236
	Switchboard	91 722 92 00
	Fax	91 722 95 83
Sweden (Upplands Vasby)	Website: support.euro.dell.com	
International Access Code: 00	E-mail: http://support.euro.dell.com/se/sv/emaildell/	
Country Code: 46	Technical Support	08 590 05 199
City Code: 8	Relational Customer Care	08 590 05 642
	Home/Small Business Customer Care	08 587 70 527
	Employee Purchase Program (EPP) Support	20 140 14 44
	Technical Support Fax	08 590 05 594
	Sales	08 590 05 185
Switzerland (Geneva)	Website: support.euro.dell.com	

International Access Code: 00	E-mail: Tech_support_central_Europe@dell.com		
Country Code: 41	E-mail for French-speaking HSB and Corporate Customers: support.euro.dell.com/ch/fr/emaildell/		
City Code: 22	Technical Support (Home and Small Business)	0844 811 411	
	Technical Support (Corporate)	0844 822 844	
	Customer Care (Home and Small Business)	0848 802 202	
	Customer Care (Corporate)	0848 821 721	
	Fax	022 799 01 90	
	Switchboard	022 799 01 01	
Taiwan	Website: support.ap.dell.com		
International Access Code: 002	E-mail: ap_support@dell.com		
	Technical Support (OptiPlex, Latitude, Inspiron, Dimension, and Electronics and Accessories)	toll-free: 00801 86 1011	
Country Code: 886	Technical Support (PowerApp, PowerEdge, PowerConnect, and PowerVault)	toll-free: 00801 60 1256	
	Transaction Sales	toll-free: 00801 65 1228	
	Corporate Sales	toll-free: 00801 651 227	
Thailand	Website: support.ap.dell.com		
International Access Code: 001	Technical Support (OptiPlex, Latitude, and Dell Precision)	toll-free: 1800 0060 07	
	Technical Support (PowerApp, PowerEdge, PowerConnect, and PowerVault)	toll-free: 1800 0600 09	
Country Code: 66	Customer Service (Penang, Malaysia)	604 633 4949	
	Corporate Sales	toll-free: 1800 006 009	
	Transaction Sales	toll-free: 1800 006 006	
Trinidad/Tobago	General Support	1-800-805-8035	
Turks and Caicos Islands	General Support	toll-free: 1-866-540-3355	
U.K. (Bracknell)	Website: support.euro.dell.com		
International Access Code: 00	Customer Care website: support.euro.dell.com/uk/en/ECare/Form/Home.asp		
	E-mail: dell_direct_support@dell.com		
Country Code: 44	Technical Support (Corporate/Preferred Accounts/PAD [1000+ employees])	0870 908 0500	
	Technical Support (direct and general)	0870 908 0800	
	Global Accounts Customer Care	01344 373 186	
	Home and Small Business Customer Care	0870 906 0010	
	Corporate Customer Care	01344 373 185	
	Preferred Accounts (500-5000 employees) Customer Care	0870 906 0010	
	Central Government Customer Care	01344 373 193	
	Local Government & Education Customer Care	01344 373 199	
	Health Customer Care	01344 373 194	
	Home and Small Business Sales	0870 907 4000	
	Corporate/Public Sector Sales	01344 860 456	
	Home and Small Business Fax	0870 907 4006	
	Uruguay	General Support	toll-free: 000-413-598-2521
	U.S.A. (Austin, Texas)	Automated Order-Status Service	toll-free: 1-800-433-9014
AutoTech (portable and desktop computers)		toll-free: 1-800-247-9362	
Consumer (Home and Home Office)			
Technical Support		toll-free: 1-800-624-9896	
Customer Service		toll-free: 1-800-624-9897	
DellNet™ Service and Support		toll-free: 1-877-Dellnet (1-877-335-5638)	
Employee Purchase Program (EPP) Customers		toll-free: 1-800-695-8133	
Financial Services website: www.dellfinancialservices.com			
Financial Services (lease/loans)		toll-free: 1-877-577-3355	
Financial Services (Dell Preferred Accounts [DPA])		toll-free: 1-800-283-2210	
Business			
Customer Service and Technical Support		toll-free: 1-800-822-8965	
Employee Purchase Program (EPP) Customers		toll-free: 1-800-695-8133	
Printers and Projectors Technical Support		toll-free: 1-877-459-7298	
Public (government, education, and healthcare)			
Customer Service and Technical Support		toll-free: 1-800-456-3355	
Employee Purchase Program (EPP) Customers		toll-free: 1-800-234-1490	



	Dell Sales	toll-free: 1-800-289-3355 or toll-free: 1-800-879-3355
	Dell Outlet Store (Dell refurbished computers)	toll-free: 1-888-798-7561
	Software and Peripherals Sales	toll-free: 1-800-671-3355
	Spare Parts Sales	toll-free: 1-800-357-3355
	Extended Service and Warranty Sales	toll-free: 1-800-247-4618
	Fax	toll-free: 1-800-727-8320
	Dell Services for the Deaf, Hard-of-Hearing, or Speech-Impaired	toll-free: 1-877-DELLTTY (1-877-335-5889)
U.S. Virgin Islands	General Support	1-877-673-3355
Venezuela	General Support	8001-3605

[Back to Contents Page](#)

[Back to Contents Page](#)

Dell™ PowerEdge™ 800 Systems Installation and Troubleshooting Guide

Notes, Notices, and Cautions

-  **NOTE:** A NOTE indicates important information that helps you make better use of your computer.
 -  **NOTICE:** A NOTICE indicates either potential damage to hardware or loss of data and tells you how to avoid the problem.
 -  **CAUTION:** A CAUTION indicates a potential for property damage, personal injury, or death.
-

Abbreviations and Acronyms

For a complete list of abbreviations and acronyms, see the Glossary in your *User's Guide*.

Information in this document is subject to change without notice.
© 2004 Dell Inc. All rights reserved.

Reproduction in any manner whatsoever without the written permission of Dell Inc. is strictly forbidden.

Trademarks used in this text: *Dell*, the *DELL* logo, *PowerEdge*, *PowerVault*, *Dell OpenManage*, *Dimension*, *Inspiron*, *OptiPlex*, *Latitude*, *Dell Precision*, *PowerApp*, *PowerConnect*, and *DellNet* are trademarks of Dell Inc.

Other trademarks and trade names may be used in this document to refer to either the entities claiming the marks and names or their products. Dell Inc. disclaims any proprietary interest in trademarks and trade names other than its own.

[Back to Contents Page](#)